



TS

Zippie® TS | TS SE

with transit option without transit option

Supplier: This manual must be given to the user of this wheelchair.

User: Before using this wheelchair read this entire manual and save for future reference.



Owner's Manual



SUNRISE LISTENS

Thank you for choosing a Quickie wheelchair. We want to hear your questions or comments about this manual, the safety and reliability of your chair, and the service you receive from your Sunrise supplier. Please feel free to write or call us at the address and telephone number below:

**Sunrise Medical
Customer Service Department
7477 East Dry Creek Parkway
Longmont, Colorado 80503
(303) 218-4500 or (800) 333-4000**

Be sure to return your warranty card, and let us know if you change your address. This will allow us to keep you up to date with information about safety, new products and options to increase your use and enjoyment of this wheelchair. If you lose your warranty card, call or write and we will gladly send you a new one.

FOR ANSWERS TO YOUR QUESTIONS

Your authorized supplier knows your wheelchair best, and can answer most of your questions about chair safety, use and maintenance. For future reference, fill in the following:

Supplier: _____

Address: _____

Telephone: _____

Serial #: _____ Date/Purchased: _____

I. INTRODUCTION	2	G.Pneumatic Tires	11
II. TABLE OF CONTENTS	3	H. Positioning Belts (Optional)	11
III. YOUR CHAIR AND ITS PARTS	4	I. Power Drive.....	11
IV. NOTICE - READ BEFORE USE	4	J. Push Handles	11
A. Choose the right chair & Safety Options.....	4	K. Quick-Release Axles.....	11
B. Review This Manual Often.....	4	L. Rear Wheels.....	12
C. Warnings	4	M. Rear Wheel Locks.....	12
V. GENERAL WARNINGS	5	N. Modified Seat System.....	12
A. Weight Limit.....	5	O. Upholstery Fabric	12
B. Weight Training.....	5	IX. SET-UP AND ADJUSTMENTS	13
C. Getting to Know Your Chair.....	5	A. Backrest	13
D. To Reduce The Risk of an Accident	5	B. Swing In/Swing Out Hangers and Footrests	13
E. Safety Checklist.....	5	C. Swing-Away Hangers (60°, 70°, or 90°)	13
F. Changes & Adjustments.....	5	D. Articulating Legrest (Optional)	14
G. Environmental Conditions	5	E. Elevating and 90° Elevating Legrests (Optional)	14
H. Terrain	5	F. Kids & Adult Angle Adjustable Footplate.....	14
I. Street Use	5	G. Aluminum Footplate	14
J. Motor Vehicle Safety.....	6	H. 90° Footboard.....	15
K. When You Need Help.....	6	I. Flip-up Armrest.....	15
VI. WARNINGS: FALLS & TIP-OVERS	6	J. Adjustable Locking Flip-up Armrest (Optional)	15
A. Center of Balance	6	K. Height-Adjustable Armrest (Optional).....	15
B. Dressing or Changing Clothes	6	L. Wheel Locks	16
C. Wheelies.....	7	M. Quick-Release Axles	16
D. Obstacles	7	N. Hub Lock	16
E. Reaching or Leaning	7	O. Caster Forks	16
F. Moving Backward.....	7	P. Caster Plates	17
G. Ramps, Slopes & Side Hills.....	7	Q. Anti-Tip Tubes - Rear and Front	17
H. Transfers.....	8	R. Rear Wheel Adjustments	18
I. Curbs & Steps	8	S. Seat Depth	18
J. Stairs.....	8	T. Solid Back And Seat Insert	19
K. Escalators	8	U. Tilt-in-Space	19
VII. WARNINGS: FOR SAFE USE	9	V. Cable Adjustment Procedure	19
A. Transit Use	9	W. Cross Brace	19
B. Learning To Do A “Wheelie”	9	X. Strut Tube Assembly	20
C. Descending A Curb or Single Step	9	Y. Folding the Chair	20
D. Climbing A Curb or Single Step.....	9	Z. Growing Seat Pan (Optional)	20
E. Climbing Stairs	9	AA. Check-Out.....	20
F. Descending Stairs.....	10	X. TROUBLESHOOTING	21
G. Maintenance	10	XI. MAINTENANCE	22
VIII. WARNINGS: COMPONENTS & OPTIONS	10	A. Introduction	22
A. Transit Option	10	B. Maintenance Chart.....	22
B. Anti-Tip Tubes (Optional)	10	C. Maintenance Tips.....	22
C. Armrests	10	D. Cleaning	22
D. Cushions & Sling Seats	10	E. Storage Tips	22
E. Fasteners	11	XII. SUNRISE LIMITED WARRANTY	23
F. Footrests	11		

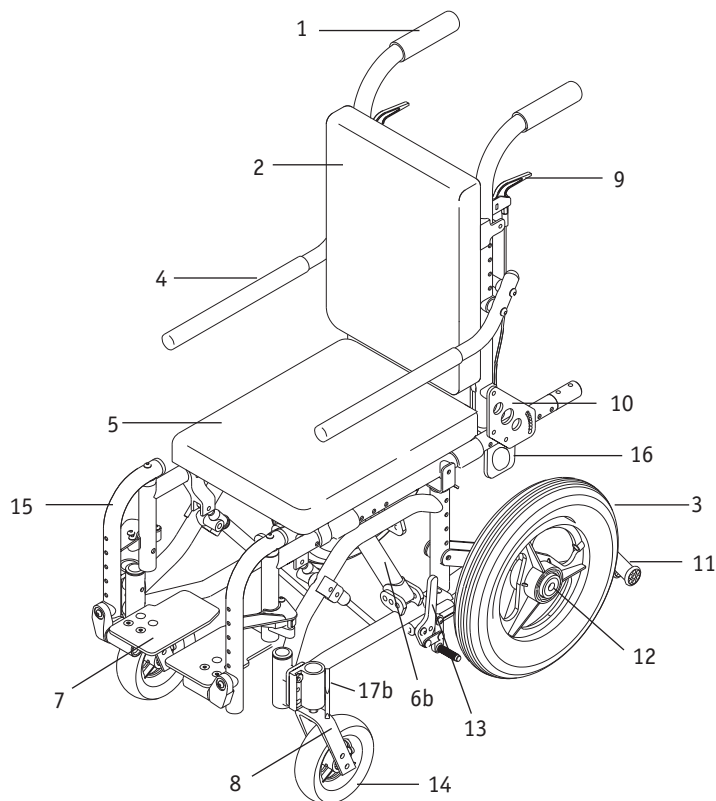

1. Push handle/folding
2. Solid back
3. Rear tire
4. Flip-up armrest
5. Solid seat
- 6a. Strut tube (not shown)
- 6b. Crossbrace
7. Footplate
8. Caster fork
9. Tilt-in-space mechanism release lever
10. Backrest pivot plate
11. Rear anti-tip tube
12. Quick-release button
13. Wheel lock
14. Caster tire
15. Swing-away footrest (optional)
16. Rear securement point (optional)
- 17a. Front securement point in forward position (optional) (not shown)
- 17b. Front securement point in trailing position (optional)

IV. NOTICE: READ BEFORE USE

A. CHOOSE THE RIGHT CHAIR & SAFETY OPTIONS

Sunrise provides a choice of many wheelchair styles to meet the needs of the wheelchair rider. However, final selection of the type of wheelchair, options and adjustments rests solely with you and your health care advisor. Choosing the best chair and set-up for your safety depends on such things as:

1. Your disability, strength, balance and coordination.
2. The types of hazards you must overcome in daily use (where you live and work, and other places you are likely to use your chair).
3. The need for options for your safety and comfort (such as anti-tip tubes, positioning belts, or special seating systems).

B. REVIEW THIS MANUAL OFTEN

Before using this chair you, and each person who may assist you, should read this entire manual and make sure to follow all instructions. Review the warnings often, until they are second nature to you.

C. WARNINGS

The word “**WARNING**” refers to a hazard or unsafe practice that may cause severe injury or death to you or to other persons. The “Warnings” are in four main sections, as follows:

1. V — GENERAL WARNINGS

Here you will find a safety checklist and a summary of risks you need to be aware of before you ride this chair.

2. VI — WARNINGS — FALLS & TIP-OVERS

Here you will learn how to avoid a fall or tip-over while you perform daily activities in your chair.

3. VII — WARNINGS — FOR SAFE USE

Here you will learn about practices for the safe use of your chair

4. VIII — WARNINGS — COMPONENTS & OPTIONS

Here you will learn about the components of your chair and options you can select for safety. Consult your authorized supplier and your health care advisor to help you choose the best set-up and options for safe use.

NOTE— Where they apply, you will also find “Warnings” in other sections of this manual. Heed all warnings in this section. If you fail to do so a fall, tip-over or loss of control may occur and cause severe injury to the rider or others.

A. WEIGHT LIMIT**⚠ WARNING**

NEVER exceed the weight limit of 165 pounds (75 kilograms), for combined weight of rider and items carried. If you do exceed the limit, damage to your chair, a fall, tip-over or loss of control may occur and cause severe injury to the rider or others.

B. WEIGHT TRAINING**⚠ WARNING**

NEVER use this chair for weight training if total weight (rider plus equipment) exceeds 165 pounds. If you do exceed the limit, damage to your chair, a fall, tip-over or loss of control may occur and cause severe injury to the rider or others.

C. GETTING TO KNOW YOUR CHAIR**⚠ WARNING**

Every wheelchair is different. Take the time to learn the feel of this chair before you begin riding. Start slowly, with easy, smooth strokes. If you are used to a different chair, you may use too much force and tip over. If you use too much force, damage to your chair, a fall, tip-over or loss of control may occur and cause severe injury to the rider or others.

D. TO REDUCE THE RISK OF AN ACCIDENT**⚠ WARNING**

- BEFORE riding, you should be trained in the safe use of this chair by your health care advisor.
- Practice bending, reaching and transfers until you know the limit of your ability. Have someone help you until you know what can cause a fall or tip-over and how to avoid doing so.
- Be aware that you must develop your own methods for safe use best suited to your level of function and ability.
- NEVER try a new maneuver on your own until you are sure you can do it safely.
- Get to know the areas where you plan to use your chair. Look for hazards and learn how to avoid them.
- Use anti-tip tubes unless you are a skilled rider of this chair and are sure you are not at risk to tip over.

If you fail to heed these warnings damage to your chair, a fall, tip-over or loss of control may occur and cause severe injury to the rider or others.

E. SAFETY CHECKLIST**⚠ WARNING**

Before Each Use Of Your Chair:

- Make sure the chair rolls easily and that all parts work smoothly. Check for noise, vibration, or a change in ease of use. (They may indicate low tire pressure, loose fasteners, or damage to your chair).
- Repair any problem. Your authorized supplier can help you find and correct the problem.
- Check to see that both quick-release rear axles are locked. When locked, the axle button will “pop out” fully. If not locked, the wheel may come off and cause you to fall.

- If your chair has anti-tip tubes, lock them in place.

NOTE– See “Anti-Tip Tubes” (Section VIII) for times you should not use them.

If you fail to heed these warnings damage to your chair, a fall, tip-over or loss of control may occur and cause severe injury to the rider or others.

F. CHANGES & ADJUSTMENTS**⚠ WARNING**

- If you modify or adjust this chair, it may increase the risk of a tip-over UNLESS you make other changes as well.
- Consult your authorized supplier BEFORE you modify or adjust your chair.
- We recommend that you use anti-tip tubes until you adapt to the change, and are sure you are not at risk to tip over.
- Unauthorized modifications or use of parts not supplied or approved by Sunrise may change the chair structure. This will void the warranty and may cause a safety hazard.

If you fail to heed these warnings damage to your chair, a fall, tip-over or loss of control may occur and cause severe injury to the rider or others.

G. ENVIRONMENTAL CONDITIONS**⚠ WARNING**

- Use extra care if you must ride your chair on a wet or slick surface. If you are in doubt, ask for help.
- Contact with water or excess moisture may cause your chair to rust or corrode. This could cause your chair to fail.
 - Do not use your chair in a shower, pool or other body of water. The chair tubing and parts are not water-tight and may rust or corrode from the inside.
 - Avoid excess moisture (for example, do not leave your chair in a damp bathroom while taking a shower).
 - Dry your chair as soon as you can if it gets wet, or if you use water to clean it.

If you fail to heed these warnings damage to your chair, a fall, tip-over or loss of control may occur and cause severe injury to the rider or others.

H. TERRAIN**⚠ WARNING**

- Your chair is designed for use on firm, even surfaces such as concrete, asphalt and indoor floors and carpeting.
- Do not operate your chair in sand, loose soil or over rough terrain. This may damage wheels or axles, or loosen fasteners of your chair.

If you fail to heed these warnings damage to your chair, a fall, tip-over or loss of control may occur and cause severe injury to the rider or others.

I. STREET USE**⚠ WARNING**

In most states, wheelchairs are not legal for use on public roads. Be alert to the danger of motor vehicles on roads or in parking lots.

- At night, or when lighting is poor, use reflective tape on your chair and clothing.
- Due to your low position, it may be hard for drivers to see you. Make eye contact with drivers before you go forward. When in doubt, yield until you are sure it is safe.

If you fail to heed these warnings damage to your chair, a fall, tip-over or loss of control may occur and cause severe injury to the rider or others.

J. MOTOR VEHICLE SAFETY

As indicated on the front cover of this user manual, identify whether your chair has been manufactured with the Transit Option installed.

WARNING

If your chair is not equipped with the Transit Option:

Zippie TS wheelchairs do not meet federal standards for motor vehicle seating.

1. NEVER let anyone sit in this chair while in a moving vehicle.
 - a. ALWAYS move the rider to an approved vehicle seat.
 - b. ALWAYS secure the rider with proper motor vehicle restraints.
2. In an accident or sudden stop the rider may be thrown from the chair. Wheelchair seat belts will not prevent this, and further injury may result from the belts or straps.
3. NEVER transport this chair in the front seat of a vehicle. It may shift and interfere with the driver.
4. ALWAYS secure this chair so that it cannot roll or shift.
5. Do not use any chair that has been involved in a motor vehicle accident.

If you fail to heed these warnings damage to your chair, a fall, tip-over or loss of control may occur and cause severe injury to the rider or others.

If your chair is equipped with the Transit Option:

See section VIII Warnings: Components and Options, Part A: Transit Option.

K. WHEN YOU NEED HELP

WARNING

For The Rider:

Make sure that each person who helps you reads and follows all warnings and instructions that apply.

For Attendants:

1. Work with the rider's doctor, nurse or therapist to learn safe methods best suited to your abilities and those of the rider.
2. Tell the rider what you plan to do, and explain what you expect the rider to do. This will put the rider at ease and reduce the risk of an accident.
3. Make sure the chair has push handles. They provide secure points for you to hold the rear of the chair to prevent a fall or tip-over. Check to make sure push handle grips will not rotate or slip off.
4. To prevent injury to your back, use good posture and proper body mechanics. When you lift or support the rider or tilt the chair, bend your knees slightly and keep your back as upright and straight as you can.
5. Remind the rider to lean back when you tilt the chair backward.
6. When you descend a curb or single step, slowly lower the chair in one easy movement. Do not let the chair drop the last few inches to the ground. This may damage the chair or injure the rider.
7. To avoid tipping, unlock and rotate anti-tip tubes up, out of the way. ALWAYS lock the rear wheels and lock anti-tip tubes in place if you must leave the rider alone, even for a moment. This will reduce the risk of a tip over or loss of control of the chair.

If you fail to heed these warnings damage to your chair, a fall, tip-over or loss of control may occur and cause severe injury to the rider or others.

VI. WARNINGS: FALLS & TIP-OVERS

A. CENTER OF BALANCE

WARNING

The point where this chair will tip forward, back, or to the side depends on its center of balance and stability. How your chair is set up, the options you select and the changes you make may affect the risk of a fall or tip-over.

1. The Most Important Adjustments Are:
 - a. The position of the rear wheels. The more you move the rear wheels forward, the more likely your chair will tip over backward.
2. The Center Of Balance Is Also Affected By:
 - a. A change in the set-up of your chair, including:
 - The distance between the rear wheels.
 - The amount of rear wheel camber.
 - The seat height and seat angle.
 - Backrest angle.
 - b. A change in your body position, posture or weight distribution.
 - c. Riding your chair on a ramp or slope.
 - d. The use of a back pack or other options, and the amount of added weight.
3. To Reduce The Risk Of An Accident:

- a. Consult your doctor, nurse or therapist to find out what axle and caster position is best for you.
- b. Consult your authorized supplier BEFORE you modify or adjust this chair. Be aware that you may need to make other changes to correct the center of balance.
- c. Have someone help you until you know the balance points of your chair and how to avoid a tip-over.
- d. Use anti-tip tubes.

If you fail to heed these warnings damage to your chair, a fall, tip-over or loss of control may occur and cause severe injury to the rider or others.

B. DRESSING OR CHANGING CLOTHES

WARNING

Your weight may shift if you dress or change clothes while seated in this chair.

To reduce the risk of a fall or tip-over:

1. Rotate the front casters until they are as far forward as possible. This makes the chair more stable.
2. Lock anti-tip tubes in place. (If your chair does not have anti-tip tubes, back it up against a wall and lock both rear wheels).

If you fail to heed these warnings damage to your chair, a fall, tip-over or loss of control may occur and cause severe injury to the rider or others.

C. WHEELIES

WARNING

Doing a “wheelie” means: balancing on the rear wheels of your chair, while the front casters are in the air. It is dangerous to do a “wheelie” as a fall or tip-over may occur. However, if you do it safely, a “wheelie” can help you overcome curbs and obstacles.

1. Consult your doctor, nurse or therapist to find out if you are a good candidate to learn to do a “wheelie.”
2. Do not attempt a “wheelie” UNLESS you are a skilled rider of this chair, or you have help.

NOTE– See Section VII-B for steps to learn to do a “wheelie.”

If you fail to heed these warnings damage to your chair, a fall, tip-over or loss of control may occur and cause severe injury to the rider or others.

D. OBSTACLES

WARNING

Obstacles and road hazards (such as potholes and broken pavement) can damage your chair and may cause a fall, tip-over or loss of control.

To avoid these risks:

1. Keep a lookout for danger – scan the area well ahead of your chair as you ride.
2. Make sure the floor areas where you live and work are level and free of obstacles.
3. Remove or cover threshold strips between rooms.
4. Install a ramp at entry or exit doors. Make sure there is not a drop off at the bottom of the ramp.
5. To Help Correct Your Center Of Balance:
 - a. Lean your upper body FORWARD slightly as you go UP over an obstacle.
 - b. Press your upper body BACKWARD as you go DOWN from a higher to a lower level.
6. If your chair has anti-tip tubes, lock them in place before you go UP over an obstacle.
7. Keep both of your hands on the handrims as you go over an obstacle.
8. Never push or pull on an object (such as furniture or a door-jamb) to propel your chair.

If you fail to heed these warnings damage to your chair, a fall, tip-over or loss of control may occur and cause severe injury to the rider or others.

E. REACHING OR LEANING

WARNING

If you reach or lean it will affect the center of balance of your chair. This may cause you to fall or tip over. When in doubt, ask for help or use a device to extend your reach.

1. NEVER reach or lean if you must shift your weight sideways or rise up off the seat.
2. NEVER reach or lean if you must move forward in your seat to do so. Always keep your buttocks in contact with the backrest.
3. NEVER reach with both hands (you may not be able to catch yourself to prevent a fall if the chair tips).
4. NEVER reach or lean to the rear unless your chair has anti-tip tubes locked in place.
5. DO NOT reach or lean over the top of the seat back. This may damage one or both backrest tubes and cause you to fall.

6. If You Must Reach Or Lean:

- a. Do not lock the rear wheels. This creates a tip point and makes a fall or tip-over more likely.
- b. Do not put pressure on the footrests.

NOTE– *Leaning forward puts pressure on the footrests and may cause the chair to tip if you lean too far.*

- c. Move your chair as close as you can to the object you wish to reach.
- d. Do not try to pick up an object from the floor by reaching down between your knees. You are less likely to tip if you reach to the side of your chair.
- e. Rotate the front casters until they are as far forward as possible. This makes the chair more stable.

NOTE– *To do this: Move your chair past the object you want to reach, then back up alongside it. Backing up will rotate the casters forward.*

- f. Firmly grasp a rear wheel or an armrest with one hand. This will help to prevent a fall if the chair tips.

If you fail to heed these warnings damage to your chair, a fall, tip-over or loss of control may occur and cause severe injury to the rider or others.

F. MOVING BACKWARD

WARNING

Use extra care when you move your chair backward. Your chair is most stable when you propel yourself forward. You may lose control or tip over if one of the rear wheels hits an object and stops rolling.

1. Propel your chair slowly and smoothly.
2. If your chair has anti-tip tubes, make sure to lock them in place.
3. Stop often and check to be sure your path is clear.

If you fail to heed these warnings damage to your chair, a fall, tip-over or loss of control may occur and cause severe injury to the rider or others.

G. RAMPS, SLOPES & SIDE HILLS

WARNING

Riding on a slope, which includes a ramp or side hill, will change the center of balance of your chair. Your chair is less stable when it is at an angle. Anti-tip tubes may not prevent a fall or tip-over.

1. Do not use your chair on a slope steeper than 10%. (A 10% slope means: one foot in elevation for every ten feet of slope length.)
2. Always go as straight up and as straight down as you can. (Do not “cut the corner” on a slope or ramp.)
3. Do not turn or change direction on a slope.
4. Always stay in the CENTER of the ramp. Make sure ramp is wide enough that you are not at risk that a wheel may fall over the edge.
5. Do not stop on a steep slope. If you stop, you may lose control of your chair.
6. NEVER use rear wheel locks to try to slow or stop your chair. This is likely to cause your chair to veer out of control.
7. Beware Of:
 - a. Wet or slippery surfaces.
 - b. A change in grade on a slope (or a lip, bump or depression). These may cause a fall or tip-over.
 - c. A drop-off at the bottom of a slope. A drop-off of as small as 3/4 inch can stop a front caster and cause the chair to tip forward.

8. To Reduce The Risk Of A Fall Or Tip-Over:
 - a. Lean or press your body UPHILL. This will help adjust for the change in the center of balance caused by the slope or side hill.
 - b. Keep pressure on the handrims to control your speed on a down slope. If you go too fast you may lose control.
 - c. Ask for help any time you are in doubt.
9. Ramps At Home & Work - For your safety, ramps at home and work must meet all legal requirements for your area. We recommend:
 - a. Width. At least four feet wide.
 - b. Guardrails. To reduce the risk of a fall, sides of ramp must have guardrails (or raised borders at least three inches high).
 - c. Slope. Not more than a 10% grade.
 - d. Surface. Flat and even, with a thin carpet or other non-skid material. (Make sure there is no lip, bump or depression.)
 - e. Bracing. Ramp must be STURDY. You may need bracing so ramp does not “bow” when you ride on it.
 - f. Avoid A Drop Off. You may need a section at the top or bottom to smooth out the transition.

If you fail to heed these warnings damage to your chair, a fall, tip-over or loss of control may occur and cause severe injury to the rider or others.

H. TRANSFER

WARNING

It is dangerous to transfer on your own. It requires good balance and agility. Be aware that there is a point during every transfer when the wheelchair seat is not below you. To Avoid A Fall:

1. Work with your health care advisor to learn safe methods.
 - a. Learn how to position your body and how to support yourself during a transfer.
 - b. Have someone help you until you know how to do a safe transfer on your own.
2. Lock the rear wheels before you transfer. This keeps the rear wheels from rolling. **NOTE**– This will NOT keep your chair from sliding away from you or tipping.
3. Make sure to keep pneumatic tires properly inflated. Low tire pressure may allow the rear wheel locks to slip.
4. Move your chair as close as you can to the seat you are transferring to. If possible, use a transfer board.
5. Rotate the front casters until they are as far forward as possible.
6. If you can, remove or swing footrests out of the way.
 - a. Make sure your feet do not catch in the space between the footrests.
 - b. Avoid putting weight on the footrests as this may cause the chair to tip.
7. Make sure armrests are out of the way and do not interfere.
8. Transfer as far back onto the seat surface as you can. This will reduce the risk that the chair will tip or move away from you.
9. Make sure armrests are locked in place prior to transfer to prevent rotation of armrests and loss of control.

If you fail to heed these warnings damage to your chair, a fall, tip-over or loss of control may occur and cause severe injury to the rider or others.

I. CURBS & STEPS

WARNING

1. Each person who helps you should read and follow the warnings “For Safe Use” (Section VII).
 2. Do not try to climb or descend a curb or step alone UNLESS you are a skilled rider of this chair and:
 - a. You can safely do a “wheelie”, and
 - b. You are sure you have the strength and balance to do so.
 3. Unlock and rotate anti-tip tubes up, out of the way, so they do not interfere.
 4. Do not try to climb a high curb or step (more than 4 inches high) UNLESS you have help. Doing so may cause your chair to exceed its balance point and tip over.
 5. Go straight up and straight down a curb or step. If you climb or descend at an angle, a fall or tip-over is likely.
 6. Be aware that the impact of dropping down from a curb or step can damage your chair or loosen fasteners.
- If you fail to heed these warnings damage to your chair, a fall, tip-over or loss of control may occur and cause severe injury to the rider or others.*

J. STAIRS

WARNING

1. NEVER use this chair on stairs UNLESS you have someone to help you. Doing so is likely to cause a fall or tip-over.
2. Persons who help you should read and follow the warnings “For Attendants”, and the “For Safe Use” (Section VII).

If you fail to heed these warnings damage to your chair, a fall, tip-over or loss of control may occur and cause severe injury to the rider or others.

K. ESCALATORS

WARNING

NEVER use this chair on an escalator, even with an attendant. If you do, a fall or tip-over is likely.

If you fail to heed these warnings damage to your chair, a fall, tip-over or loss of control may occur and cause severe injury to the rider or others.

⚠ WARNING

Before you assist a rider, be sure to read the warnings “For Attendants” (p. 12) and follow all instructions that apply. Be aware that you will need to learn safe methods best suited to your abilities.

A. TRANSIT USE**⚠ WARNING**

1. If possible and feasible, the rider should transfer to the Original Equipment Manufacturer vehicle seat and use the vehicle restraint.
2. If the wheelchair is used for transport, it must be used in a forward-facing seating position.
3. The rider must not weigh more than 165 lbs.
4. Figure 1 shows the location of the wheelchair securement points.
5. Use only with Wheelchair Tiedown and Occupant Restraint Systems (WTORS) that have been installed in accordance with the manufacturer's instructions and SAE J2249.
6. Attach WTORS to securement points in accordance with the manufacturer's instructions and SAE J2249.
7. Attach occupant restraints in accordance with the manufacturer's instructions and SAE J2249.

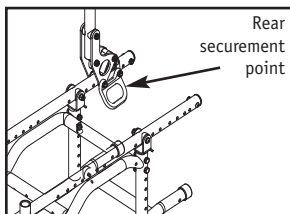
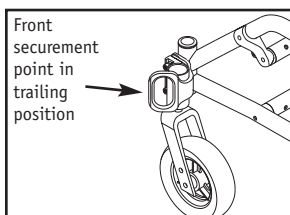
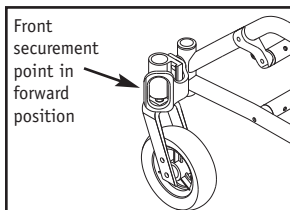

NOTE— To obtain a copy of SAE J2249 Wheelchair Tiedown and Occupant Restraint Systems for Use in Motor Vehicles, please contact: SAE International - 400 Commonwealth Drive - Warrendale, PA 15096 - 412.776.4970

If you fail to heed these warnings damage to your chair, a fall, tip-over or loss of control may occur and cause severe injury to the rider or others.

B. LEARNING TO DO A “WHEELIE”**⚠ WARNING**

Because of the limited ability to adjust the center of gravity and changes in center of gravity that may result from operating the tilt in space feature of this chair attempting to perform wheelies in the Zippie TS is not recommended.

If your doctor, nurse or therapist has determined that wheelies are appropriate, follow these steps to help the rider learn to do a “wheelie”:

1. Read and follow the warnings for “WHEELIES.”
2. Stand at the rear of the chair. You must be able to move with the chair to prevent a tip-over.
3. Keep your hands BENEATH the push handles, ready to catch the rider if the chair tips back.
4. When you are ready, have the rider place his or her hands on the forward part of the handrims.

5. Have the rider make a quick BACKWARD movement of the rear wheels, quickly followed by a hard FORWARD thrust. (This will tilt the chair up on the balance point of the rear wheels.)
6. Have the rider make small movements of the handrims to stay in balance.

If you fail to heed these warnings damage to your chair, a fall, tip-over or loss of control may occur and cause severe injury to the rider or others.

C. DESCENDING A CURB OR SINGLE STEP**⚠ WARNING**

Follow these steps to help a rider descend a curb or single step going BACKWARD:

1. Stay at the rear of the chair.
2. Several feet before you reach the edge of the curb or step, turn the chair around and pull it backward.
3. While looking over your shoulder, carefully step back until you are off the curb or stair and standing on the lower level.
4. Pull the chair toward you until the rear wheels reach the edge of the curb or step. Then allow the rear wheels to slowly roll down onto the lower level.
5. When the rear wheels are safely on the lower level, tilt the chair back to its balance point. This will lift the front casters off the curb or step.
6. Keep the chair in balance and take small steps backward. Turn the chair around and gently lower front casters to the ground.

If you fail to heed these warnings damage to your chair, a fall, tip-over or loss of control may occur and cause severe injury to the rider or others.

D. CLIMBING A CURB OR SINGLE STEP**⚠ WARNING**

Follow these steps to help the rider climb a curb or single step going FORWARD:

1. Stay behind the chair.
2. Face the curb and tilt the chair up on the rear wheels so that the front casters clear the curb or step.
3. Move forward, placing the front casters on the upper level as soon as you are sure they are past the edge.
4. Continue forward until the rear wheels contact the face of the curb or step. Lift and roll the rear wheels to the upper level.

If you fail to heed these warnings damage to your chair, a fall, tip-over or loss of control may occur and cause severe injury to the rider or others.

E. CLIMBING STAIRS**⚠ WARNING**

1. Use at least two attendants to move a chair and rider up stairs.
2. Move the chair and rider BACKWARD up the stairs.
3. The person at the rear is in control. He or she tilts the chair back to its balance point.
4. A second attendant at the front firmly grasps a non-detachable part of the front frame and lifts the chair up and over one stair at a time.
5. The attendants move to the next stair up. Repeat for each stair, until you reach the landing.

If you fail to heed these warnings damage to your chair, a fall, tip-over or loss of control may occur and cause severe injury to the rider or others.

F. DESCENDING STAIRS

WARNING

1. Use at least two attendants to move a chair and rider down stairs.
2. Move the chair and rider FORWARD down the stairs.
3. The person at the rear is in control. He or she tilts the chair to the balance point of the rear wheels and rolls it to the edge of the top step.
4. A second attendant stands on the third step from the top and grasps the chair frame. He or she lowers the chair one step at a time by letting the rear wheels roll over the stair edge.
5. The attendants move to the next stair down. Repeat for each stair, until you reach the landing.

If you fail to heed these warnings damage to your chair, a fall, tip-over or loss of control may occur and cause severe injury to the rider or others.

G. MAINTENANCE

WARNING

1. Inspect and maintain this chair strictly per maintenance chart.
2. If you detect a problem, make sure to service or repair the chair before use.
3. At least once a year, have a complete inspection, safety check and service of your chair made by an authorized supplier.

If you fail to heed these warnings damage to your chair, a fall, tip-over or loss of control may occur and cause severe injury to the rider or others. For additional maintenance information see Section XI: Maintenance.

A. TRANSIT OPTION

WARNING

1. Use only Wheelchair Tiedown and Occupant Restraint Systems (WTORS) which meet the requirements of SAE J2249 Recommended Practice - Wheelchair Tiedown and Occupant Restraint Systems For Use in Motor Vehicles. Do not use WTORS designed to rely on the wheelchair structure to transfer occupant restraint loads to the vehicle.
2. The wheelchair has been dynamically tested in a forward-facing mode for a 48-km/h frontal impact test. The wheelchair must be forward-facing during transport.
3. In order to reduce the potential of injury to vehicle occupants, wheelchair-mounted accessories, such as trays and respiratory equipment, should be removed and secured separately.
4. Postural supports and positioning devices should not be relied on for occupant restraint.
5. Do not alter or substitute wheelchair frame parts, components or seating.
6. Sudden stops or impacts can structurally damage your chair. Chairs involved in such incidents should be replaced.

If you fail to heed these warnings damage to your chair, a fall, tip-over or loss of control may occur and cause severe injury to the rider or others.

B. ANTI-TIP TUBES (REAR STD. FRONT OPTIONAL)

WARNING

Anti-tip tubes can help keep your chair from tipping over backward in most normal conditions.

1. Sunrise Recommends Use Of Anti-Tip Tubes:
 - a. UNLESS you are a skilled rider of this chair and are sure you are not at risk to tip over.
 - b. Each time you modify or adjust your chair. The change may make it easier to tip backward. Use anti-tip tubes until you adapt to the change, and are sure you are not at risk to tip over.
2. When locked in place (in the “down” position) anti-tip tubes should be BETWEEN 1 1/2 to 2 inches off the ground.
 - a. If set too HIGH, they may not prevent a tip-over.

VIII. WARNINGS: COMPONENTS & OPTIONS

- b. If set too LOW, they may “hang up” on obstacles you can expect in normal use. If this occurs, you may fall or your chair may tip over.

3. Keep Anti-Tip Tubes Locked In Place UNLESS:
 - a. You have an attendant; or
 - b. You have to climb or descend a curb, or overcome an obstacle, and can safely do so without them. At these times, make sure anti-tip tubes are up, out of the way.

If you fail to heed these warnings damage to your chair, a fall, tip-over or loss of control may occur and cause severe injury to the rider or others.

C. ARMRESTS

WARNING

Armrests detach and will not bear the weight of this chair.

1. NEVER lift this chair by its armrests. They may come loose or break.
2. Lift this chair only by non-detachable parts of the main frame.

If you fail to heed these warnings damage to your chair, a fall, tip-over or loss of control may occur and cause severe injury to the rider or others.

D. CUSHIONS & SLING SEATS

WARNING

1. Quickie sling seats and standard foam cushions are not designed for the relief of pressure.
2. If you suffer from pressure sores, or if you are at risk that they will occur, you may need a special seat system or a device to control your posture. Consult your doctor, nurse or therapist to find out if you need such a device for your well-being.
3. When using the growing seat pan (optional), when removing and reattaching the seat pan, check for engagement by pulling up lightly on the seat pan. It should not move upward.

If you fail to heed these warnings damage to your chair, a fall, tip-over or loss of control may occur and cause severe injury to the rider or others.

E. FASTENERS

WARNING

Many of the screws, bolts and nuts on this chair are special high-strength fasteners. Use of improper fasteners may cause your chair to fail.

1. ONLY use fasteners provided by an authorized supplier (or ones of the same type and strength, as indicated by the markings on the heads).
2. Over- or under-tightened fasteners may fail or cause damage to chair parts.
3. If bolts or screws become loose, tighten them as soon as you can.

If you fail to heed these warnings damage to your chair, a fall, tip-over or loss of control may occur and cause severe injury to the rider or others.

F. FOOTRESTS

WARNING

1. At the lowest point, footrests should be AT LEAST 2 1/2 INCHES off the ground. If set too LOW, they may “hang up” on obstacles you can expect to find in normal use. This may cause the chair to stop suddenly and tip forward.
2. To Avoid A Trip Or Fall When You Transfer:
 - a. Make sure your feet do not “hang up” or get caught in the space between the footrests.
 - b. Avoid putting weight on the footrests, as the chair may tip forward.
3. NEVER lift this chair by the footrests. Footrests detach and will not bear the weight of this chair. Lift this chair only by non-detachable parts of the main frame.

If you fail to heed these warnings damage to your chair, a fall, tip-over or loss of control may occur and cause severe injury to the rider or others.

G. PNEUMATIC TIRES

WARNING

Proper inflation extends the life of your tires and makes your chair easier to use.

1. Do not use this chair if any of the tires is under- or over-inflated. Check weekly for proper inflation level, as listed on the tire sidewall.
2. Low pressure in a rear tire may cause the wheel lock on that side to slip and allow the wheel to turn when you do not expect it.
3. Low pressure in any of the tires may cause the chair to veer to one side and result in a loss of control.
4. Over-inflated tires may burst.

If you fail to heed these warnings damage to your chair, a fall, tip-over or loss of control may occur and cause severe injury to the rider or others.

H. POSITIONING BELTS (OPTIONAL)

WARNING

Use positioning belts ONLY to help support the rider’s posture. Improper use of these belts may cause severe injury to or death of the rider.

1. Make sure the rider does not slide down in the wheelchair seat. If this occurs, the rider may suffer chest compression or suffocate due to pressure from the belts.
2. The belts must be snug, but must not be so tight that they interfere with breathing. You should be able to slide your open hand, flat, between the belt and the rider.

3. A pelvic wedge or a similar device can help keep the rider from sliding down in the seat. Consult with the rider’s doctor, nurse or therapist to find out if the rider needs such a device.
4. Use positioning belts only with a rider who can cooperate. Make sure the rider can easily remove the belts in an emergency.
5. NEVER Use Positioning Belts:
 - a. As a patient restraint. A restraint requires a doctor’s order.
 - b. On a rider who is comatose or agitated.
 - c. As a motor vehicle restraint. In an accident or sudden stop the rider may be thrown from the chair. Wheelchair seat belts will not prevent this, and further injury may result from the belts or straps.

If you fail to heed these warnings damage to your chair, a fall, tip-over, loss of control may occur or cause severe injury to the rider or others.

I. POWER DRIVE

WARNING

Do not install a power drive on any Zippie TS wheelchair. If you do:

1. It will affect the center of balance of your chair and may cause a fall or tip-over.
2. It will alter the frame and void the warranty.

If you fail to heed these warnings damage to your chair, a fall, tip-over or loss of control may occur and cause severe injury to the rider or others.

J. PUSH HANDLES (OPTIONAL)

WARNING

When you have an attendant, make sure that this chair has push handles.

1. Push handles provide secure points for an attendant to hold the rear of this chair, to prevent a fall or tip-over.
2. Check to make sure push handle grips will not rotate or slip off.

If you fail to heed these warnings damage to your chair, a fall, tip-over or loss of control may occur and cause severe injury to the rider or others.

K. QUICK-RELEASE AXLES

WARNING

1. Do not use this chair UNLESS you are sure that both quick-release rear axles are locked. An unlocked axle may come off during use and cause a fall.
2. An axle is not locked until the quick-release button pops out fully. An unlocked axle may come off during use, resulting in a fall, tip-over or loss of control and cause severe injury to the rider or others.
3. Routinely inspect. Replace if worn or bent.
 - Quick-Release Axles should be inspected for function and any signs of wear or bending. Replace as necessary.

WARNING

Routinely Inspect. Replace if worn or bent.

If you fail to heed these warnings damage to your chair, a fall, tip-over or loss of control may occur and cause severe injury to the rider or others.

L. REAR WHEELS

WARNING

A change in set-up of the rear wheels will affect the center of balance of your chair.

1. The farther you move the rear axles FORWARD, the more likely it is that your chair will tip over backward.
2. Consult your doctor, nurse or therapist to find the best rear axle set-up for your chair. Do not change the set-up UNLESS you are sure you are not at risk to tip over.
3. Adjust the rear wheel locks after you make any change to the rear axles.
 - a. If you fail to do so, the locks may not work.
 - b. Make sure lock arms embed in tires at least 1/8 inch when locked.

If you fail to heed these warnings damage to your chair, a fall, tip-over or loss of control may occur and cause severe injury to the rider or others.

M. REAR WHEEL LOCKS

WARNING

Rear wheel locks are NOT designed to slow or stop a moving wheelchair. Use the only to keep the rear wheels from rolling when your chair is at a complete stop.

1. NEVER use rear wheel locks to try to slow or stop your chair when it is moving. Doing so may cause you to veer out of control.
2. To keep the rear wheels from rolling, always set both rear wheel locks when you transfer to or from your chair.
3. Low pressure in a rear tire may cause the wheel lock on that side to slip and may allow the wheel to turn when you do not expect it.
4. Make sure lock arms embed in tires at least 1/8 inch when locked. If you fail to do so, the locks may not work.

If you fail to heed these warnings damage to your chair, a fall, tip-over or loss of control may occur and cause severe injury to the rider or others.

N. MODIFIED SEAT SYSTEMS

WARNING

Use of a seat system not approved by Sunrise may alter the center of balance of this chair. This may cause the chair to tip over.

1. Do not change the seat system of your chair UNLESS you consult your authorized supplier first.
2. Use of a seat system not approved by Sunrise may affect the folding mechanism of this chair.
3. Use of a seating system not provided by Sunrise is prohibited for transit use.

If you fail to heed these warnings damage to your chair, a fall, tip-over or loss of control may occur and cause severe injury to the rider or others.

O. UPHOLSTERY FABRIC

WARNING

1. Replace worn or torn fabric of seat and seat back as soon as you can. If you fail to do so, the seat may fail.
2. Sling fabric will weaken with age and use. Look for fraying or thin spots, or stretching of fabrics at rivet holes.
3. “Dropping down” into your chair will weaken fabric and result in the need to inspect and replace the seat more often.
4. Be aware that laundering or excess moisture will reduce flame retardation of the fabric.

If you fail to heed these warnings damage to your chair, a fall, tip-over or loss of control may occur and cause severe injury to the rider or others.

NOTE– Setting the wheelchair on a flat surface helps make these procedures easier.

NOTE on Torque Settings– A torque setting is the optimum tightening which should be made on a particular fastener. A torque wrench which measures in.-lbs. should be used when tightening fasteners on Sunrise wheelchairs. Unless otherwise noted, use a torque setting of 60 in.-lbs. when setting up this wheelchair.

A. BACKREST 1 2

To Secure The Backrest For Operation:

- a) Lift backrest to upright position.
- b) When secured, backrest pin will lock into place.

NOTE– Zippie series wheelchairs are shipped with the backrest in a folded position.

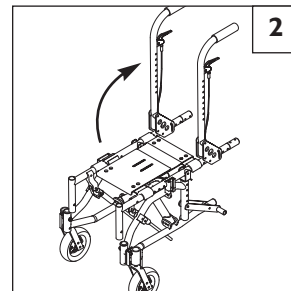
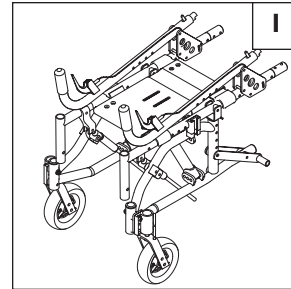

B. SWING-IN/SWING-OUT HANGERS AND FOOTRESTS (70°, 80°)

1. Installation 3

- a. Place swing-in/swing-out pivot saddle into the receiver on front frame tube with the footrest facing outward from the frame. (3-A)
- b. Rotate the footrest inward until it locks into place on locking bolt. (3-B)

2. Removal

- a. To remove footrest, push release latch toward the frame.
- b. Rotate footrest inward and lift. Or, pull footrest away from frame and rotate outward.

3. Height Adjustment 4

NOTE– It is recommended that you maintain a minimum of 2.0 inches between the lowest point on the footrest and the floor.

- a. Loosen set screw (C) using a 3/16 inch hex key.
- b. Slide footrest extension up or down inside frame tube to desired height.
- c. Tighten set screw. Use a torque setting of 144 in.-lbs (16.27 Nm).

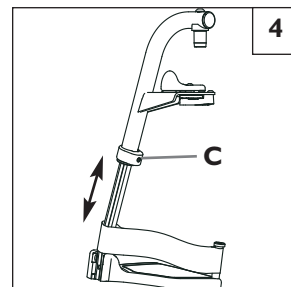
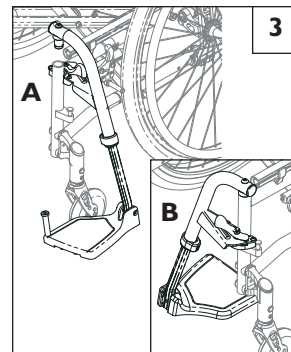

C. SWING-AWAY HANGERS (60°, 70°, or 90°) 5

1. Attaching/Removal

- a) Place swing-away pivot saddle (A) into the receiver on front frame tube with the footrest facing outward from the frame.
- b) Rotate the footrest inward until it locks into place on locking bolt.
- c) To remove hanger, push release latch (B) toward the frame, rotate footrest outward, and lift.

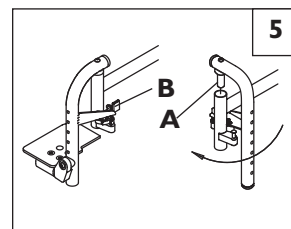

D. ARTICULATING LEGREST (Optional) 6

1. Attaching/Removal

- a) Place swing-away pivot saddle (A) into the receiver on front frame tube with the footrest facing outward from the frame.
- b) Rotate the footrest inward until it locks into place on locking bolt.
- c) To remove hanger, push release latch (B) toward the frame, rotate footrest outward, and lift.

2. Elevating

- a) To raise legrest, lift to desired position. Legrest will automatically lock in place.
- b) To lower legrest, while seated in chair hold lever (C) down, lower legrest to desired position, then release lever. Legrest will automatically lock in place.

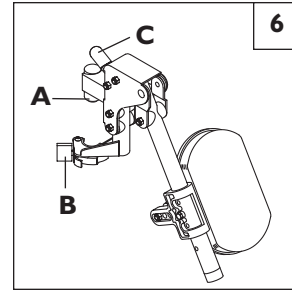

E. ELEVATING AND 90° ELEVATING LEGRESTS (Optional)

7 8

1. Attaching/Removal

- a) Place swing-away pivot saddle (A) into the receiver on front frame tube with the footrest facing outward from the frame.
- b) Rotate the footrest inward until it locks into place on locking bolt.
- c) To remove hanger, push release latch (B) toward the frame, rotate footrest outward, and lift.

2. Elevating

- a) To raise legrest, lift to desired position. Legrest will automatically lock in place.
- b) To lower legrest, while seated in chair hold lever (C) down, lower legrest to desired position, then release lever. Legrest will automatically lock in place.

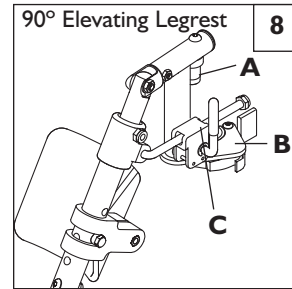
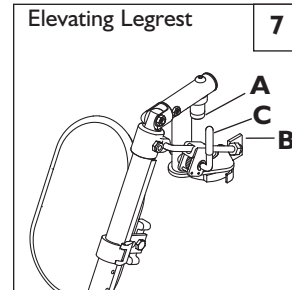

F. KIDS & ADULT ANGLE ADJUSTABLE FOOTPLATE 10 11

1. Height Adjustment 10

- a) Remove the retaining bolt from the frame tube (A).
- b) Move footplate assembly to desired height.
- c) Left and right footrest will normally be at equal height.
- d) Replace and tighten bolt.

2. Angle Adjustment 11

- a) Loosen fasteners (B) until the adjustable clamp and footplate rotate freely on the mounting tube.
- b) Adjust the angle of the footplate.
- c) Tighten nuts.

3. Position Adjustment 11

- a) Remove footplate fasteners (B).
- b) Move footplate to the desired location.
- c) Replace and tighten fasteners.

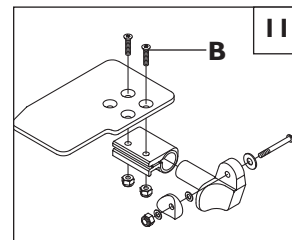
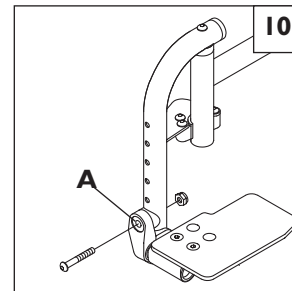

G. ALUMINUM FOOTPLATE 12

1. Height Adjustment

- a) Remove set screws (A) from frame tube.
- b) Slide footplate to desired height.
- c) The adjustment on each side of the footrest will normally be of equal height.
- d) Replace and tighten set screws.

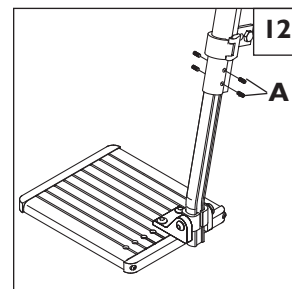

H. 90° FOOTBOARD 13

1. Height Adjustment

- a) Loosen the nuts on the footplate clamp assembly (A).
- b) Slide footplate clamps to desired height.
- c) Tighten nuts.

2. Angle Adjustment

- a) Loosen nuts under the footplate assembly (B) until the adjustable clamp rotates freely on the supporting tube.
- b) Adjust the angle of the footplate.
- c) Slide it forward or back for correct placement.
- d) Tighten nuts.

3. Removing Footboard

- a) Unscrew the lock knobs (C) and lift out of clamp assembly.

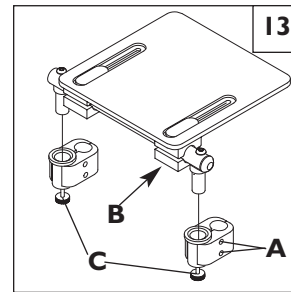

I. FLIP-UP ARMRESTS 14

1. Adjustment

Flip-up armrests are height adjustable (3") by moving the armrest assemblies up or down in the pre-drilled holes on the backrest frame tubes.

- a) To adjust armrest upward and downward, loosen cam adjustment bolt (A).
- b) Rotate armrest to desired position.
- c) Replace and tighten bolt.

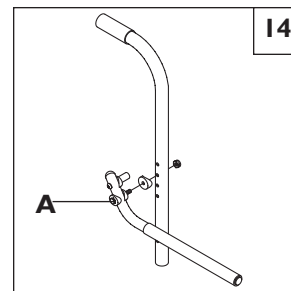

J. ADJUSTABLE LOCKING FLIP-UP ARMREST (Optional) 15

1. Height Adjustment

- a) Remove the hex nuts from the armrest (A) and angle adjustment plate (B) to release the armrest and plate.
- b) Release the bolts from the arm mount (C).
- c) Move mount up or down the back post in 1-inch increments for desired height, or within the arm mount holes for 1/4-inch increments.
- d) Replace and tighten nuts and bolts.

2. Angle Adjustment

- a) Loosen the hex nut from the angle adjustment plate (B).
- b) Tilt the armrest and plate to the desired angle.
- c) Tighten nut.

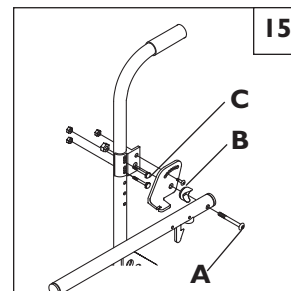

K. HEIGHT-ADJUSTABLE ARMRESTS (Optional) 16 16a

1. Installation

- a) Slide the outer armrest into the receiver mounted to the wheelchair frame.
- b) The armrest will automatically lock into place.

2. Height Adjustment

- a) Rotate release lever to second stop.
- b) Slide armrest pad up or down to desired height.
- c) Return lever to locked position against armrest.
- d) Push arm pad until upper armrest locks firmly into place.

3. Removing Armrest

- a) Rotate release lever to first stop and remove the armrest.

4. Replacing Armrest

- a) Slide armrest back into receiver.
- b) Return release lever to locked position against armrest.

5. Adjusting Armrest Receiver Fit

To tighten or loosen the fit of the outer armrest in the receiver:

- a) Loosen the bolts on the sides of the receiver.
- b) With the armrest in the receiver, squeeze the receiver to achieve the desired fit.
- c) Tighten the four bolts.

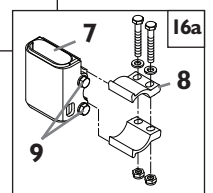
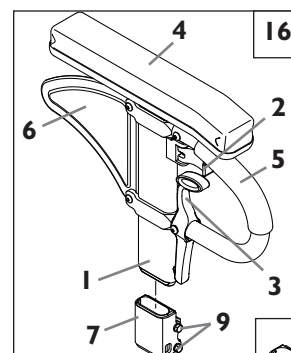

1. Outer armrest
2. Release Lever–Height
3. Release lever
4. Armrest pad
5. Transfer bar
6. Side panel
7. Receiver
8. Clamp
9. Receiver adjustment hardware

L. WHEEL LOCKS 17

WARNING

Do not operate your wheelchair without wheel locks.

1. High-Mount Wheel Lock

- a) Loosen the screws on the top of each clamp (A). Do not attempt to remove one screw at a time.
- b) Slide assembly toward rear wheel until clamp (B) embeds into tire to prevent wheel movement when in locked position.
- c) Adjust angle position.
- d) Tighten screws.

NOTE- Use a torque setting of 100 in.-lbs. when setting up wheel locks.

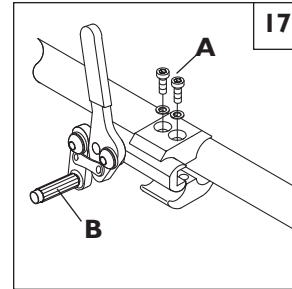

M. QUICK-RELEASE AXLES 18

1. Attaching/Removal

- a) Depress the quick-release button (A) on the axle.
- b) Slide through wheel hub and into the axle sleeve until it locks.

NOTE- The axle is not secured until the outside quick-release button pops out to its fully extended position. The ball bearings on the opposite end of the axle must be visible beyond the end of the axle sleeve.

- c) To remove the wheel hub, depress the quick-release button and lift off the hub.

2. Axle Length Adjustment

- a) To adjust the axle you will need a 3/4" wrench to turn the outside axle nuts.
- b) You will also need a 1/2" wrench to lodge the ball bearings on the opposite end of the axle and to prevent the axle from turning.
- c) Turn the outside axle nut counter-clockwise to tighten.
- d) There should only be zero to ten thousandths of an inch (.010") of play between ball bearing and the inside of the axle sleeve.

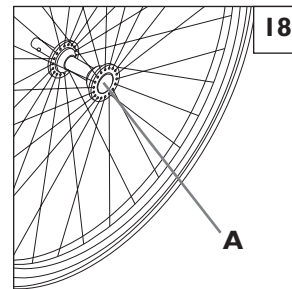

N. HUB LOCK 19 20

To operate Hub Lock 19

1. To Lock rear wheels, press button A. Lever B will flip outward.
2. To unlock wheels, press Lever B back down until Button A pops back out. Each lever operates one side of the chair. To fully lock chair, both buttons must be pushed.

NOTE- Do not engage hub lock when chair is in motion.

To adjust the cables 20

1. Loosen jam nut C using a 10mm wrench.
2. Turn adjustment screw D in out as necessary. Turning screw upward will loosen cable, turning downward will tighten cable.
3. Re-tighten jam nut C against lever mount.
4. Repeat steps 1-3 for opposite side of chair as necessary.

To adjust lever position 20

1. Remove Socket Screw E and Washer F from lever and backrest.
2. Choose desired hole in backrest to mount lever and re-install screw and washer.
3. Repeat steps 1-2 for opposite side of chair.

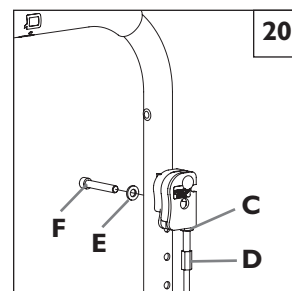
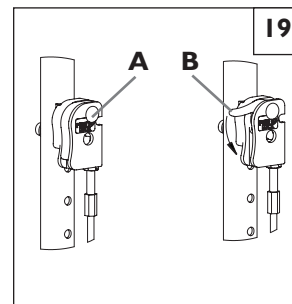

O. CASTER FORKS 21

1. Caster Fork Adjustment

- a) Loosen the bolt (A) and remove the caster.
- b) Either change caster size and/or position the caster upward or downward in pre-drilled holes (1" apart) on caster fork.
- c) Replace bolt and tighten securely.
- d) Repeat with other caster.

NOTE- Two-hole caster forks allow interchanging 5", 6" and 8" casters and adjusting seat height. These changes may affect the floor to seat height.

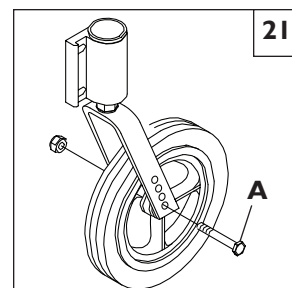

P. CASTER PLATES 22 23 24

1. Angle Adjustment 22 23

- a) Loosen the bolts (A) that secure the caster assembly until the eccentric washers are free to rotate.
- b) Place a large right triangle against a flat work surface and the front surface of the caster bearing housing. This will align the caster stem rotational axis perpendicular to the work surface.
- c) Align the eccentric washers and retighten the bolts.
- d) Repeat the process for the other caster.

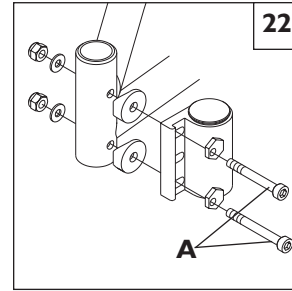

2. Angle Adjustment: Caster Plates with Transit Option 23 24

- a) Loosen the bolts (A) that secure the caster assembly.
- b) Place a large right triangle against the flat surface and the front surface of the caster bearing housing. This will align the caster stem rotational axis perpendicular to the flat surface.
- c) Align the eccentric washers and retighten the bolts.
- d) Repeat the process for the other caster.

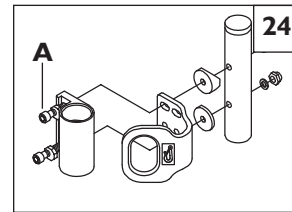
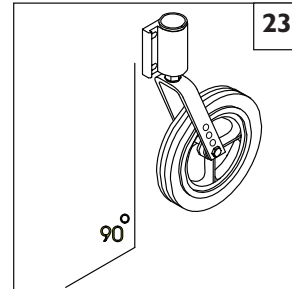

Q. ANTI-TIP TUBES - REAR AND FRONT 25 26 27

1. To Insert Anti-Tip Tubes into Receivers 25

- a) Press the anti-tip release button (A) on the anti-tip tube so that the release pin (B) is drawn inside.
- b) Insert the tube into the anti-tip receiver.
- c) Turn the anti-tip tube until release pin is positively engaged in the receiver mounting hole (C).
- d) Insert second anti-tip tube the same way.

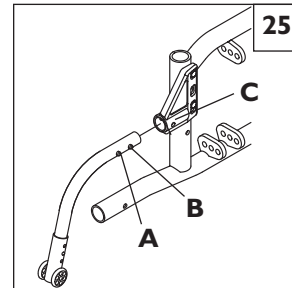

2. To Adjust Anti-Tip Height 26

- a) Press the anti-tip wheel release button (A) so the release pin is drawn inside.
- b) Raise or lower to one of the three pre-drilled holes.
- c) Turn the anti-tip tube until release pin is positively engaged in the receiving hole (B).
- d) Adjust the second anti-tip tube wheel the same way. Both wheels should be exactly the same height.

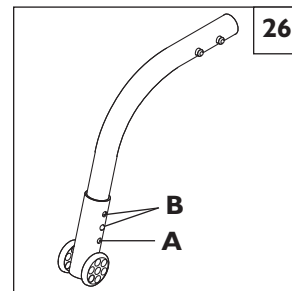

3. To Adjust the Rear Anti-Tip Bracket Height 27

- a) Remove the two hex bolts (A).
- b) Raise or lower as needed.
- c) Replace and tighten bolts.

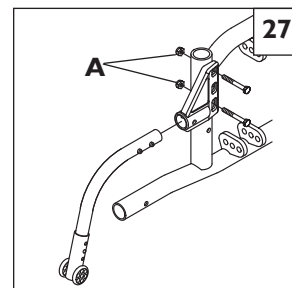

NOTE- Rear anti-tip brackets are attached with axle plate hardware (see Seat Height Adjustment section).

R. REAR WHEEL ADJUSTMENTS 28 29

1. Seat Height Adjustment 28

- a) Remove the rear wheel (See Quick-Release Axle).
- b) Remove the bolts (A) from the axle sleeve bracket (B).
- c) Raise or lower axle sleeve bracket to desired height.
- d) Additional seat height adjustment may be made by flipping axle sleeve bracket top to bottom (as shown) and exchanging them from side to side.
- e) Replace and tighten bolts. Replace wheel.

NOTE— Reversing the axle sleeve brackets from side to side may affect wheelbase width (see Wheelbase Width).

2. Wheelbase Width Adjustment 29

- a) Remove the rear wheel (See Quick-Release Axle).
- b) Remove the bolts from the axle sleeve bracket (A) on each side of the chair.
- c) Reverse the axle sleeves (A) with the wide side (B) facing away from the chair for increased width.
- d) Replace and tighten bolts. Replace wheel.

NOTE— To retain the same height, you must exchange the axle sleeve brackets from side to side.

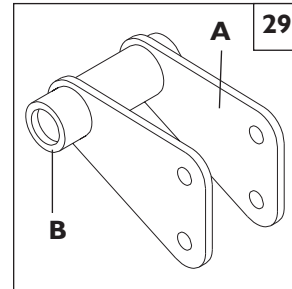
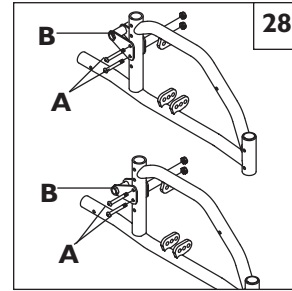

S. SEAT DEPTH 30 31

1. Pivot Plate Adjustment 30

- a) Remove the bolts (A) securing the back rest pivot plate (B) onto the tilt seat tube.
- b) Position the backrest pivot plate in the desired pre-drilled holes on the tilt seat tube. (See matrix below.)
- c) Replace bolts and tighten securely.

NOTE— A rear frame extension is available for 19" and 20" frame depths from your authorized Sunrise supplier.

2. Tilt-in-Space Tube Adjustment 31

- a) Remove the bolts (A) from the tilt brackets and strut saddles.
- b) Move the tilt seat tube (B) to position the proper frame holes according to the matrix below for the tilt bracket.
- c) Replace and tighten bolts.

NOTE— Adjusting the position of the tilt seat tube will affect the chair's center of gravity and may require you to adjust the casters to a trailing or forward position (see Caster Forks).

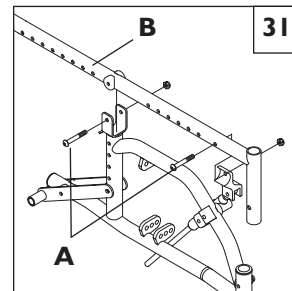
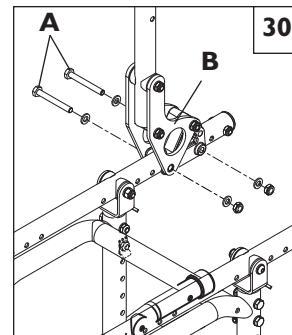
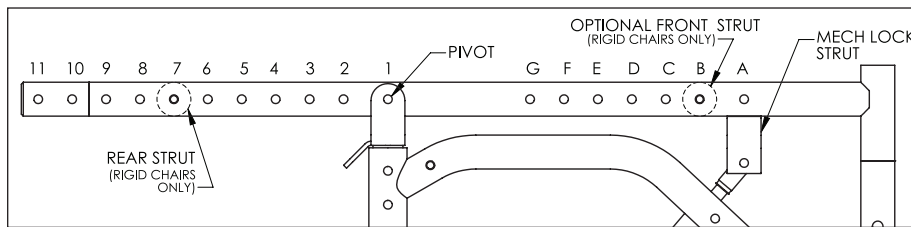

Depths (in.)		Hole Positions				
Frame Depth	Solid Seat Depth	Back Plate Position	Pivot Position	MechLok Strut Position	Rear Strut Tube Position	Front Strut Tube Position
13	11	2+4	1	A	6	B
14	12	3+5	1	A	7	B
15	13	4+6	2	B	8	A
16	14	5+7	2	B	9	A
17	15	6+8	3	C	9	A
18	16	7+9	3	C	5	A
19	17	8+10	4	D	11	A
20	18	9+11	4	D	7	A

T. SOLID BACK AND SEAT INSERT 32

1. Attaching/Removal

- a) Position seat and back on the frame.
- b) Position clamps on the seat base and backposts.
- c) Insert the quick-release pins (A) through the mounting holes on both the base and backposts.
- d) Remove the seat by reversing the above process.

NOTE- May be equipped with Jay Fit or Conventional seating (see instructions from seating Owner's Manual).

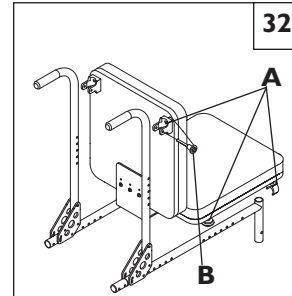

U. TILT-IN-SPACE 33 34 35

1. Tilt Adjustment 33

- a) Remove trigger release pin (A).
- b) Depress the lock lever handle (B), position to desired tilt, and release handle.
- c) Replace trigger release pin

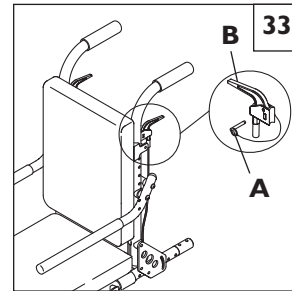

2. Tilt-in-Space Mechanism Adjustment 34

- a) Rotate the jam nut (A) clockwise.
- b) Turn the cable adjuster piece (B) until looseness is removed from cable.
- c) Tighten jam nut.

NOTE- Adjustments to tilt-in-space mechanism are recommended to be made by authorized Sunrise suppliers.

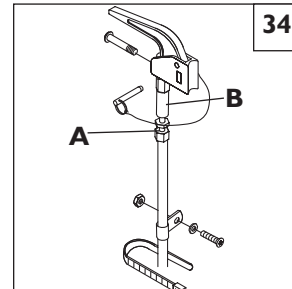

2. Foot Release 35

Depressing foot pedal (F) disengages the locking mechanism and allows the seat and back to rotate in space. Releasing the foot pedal positively locks the rockers in place.

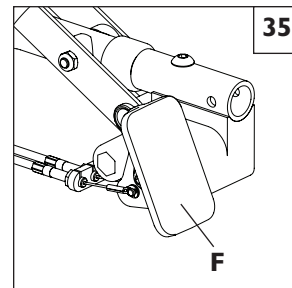

V. CABLE ADJUSTMENT PROCEDURE 36

1. Loosen jam nut (A) from adapter (B) using 10mm wrench.
2. Using a 3/8" wrench, turn adapter clockwise as shown to remove slop in cable. If the seat is not holding the tilt angle securely, the cables may be adjusted too tight, and the adapter will need to be turned counter-clockwise.
3. Once proper adjustment is obtained, re-tighten jam nut against adapter.
4. Repeat for opposite side of chair as necessary.

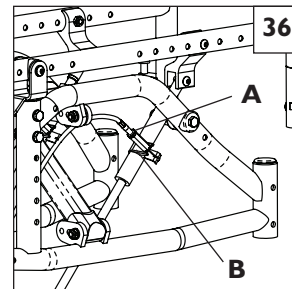

W. CROSS BRACE 37

Adjustment

1. Remove the four bolts (A) that attach the cross brace to the side frames.
2. Move the cross brace to the desired location on the tabs (B).
3. Replace and tighten the bolts.

NOTE- Align the bolts through holes in the tabs that correspond on each side. Re-tighten bolts to 100 in.-lbs. Cross braces have 2" of width growth.

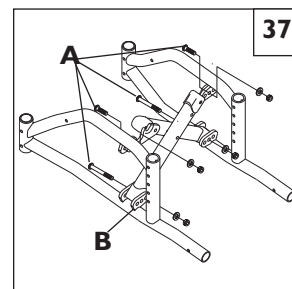

X. STRUT TUBE ASSEMBLY 38

NOTE- Strut Tubes are installed on rigid chairs.

Width Adjustment

1. Remove hardware (C) from all strut tubes.
2. Slide the adjustable extension (D) to the desired width.
3. Replace and tighten the saddle bolts in the strut tubes.

NOTE- Strut tubes have 2" width adjustment available. Size changes may require a larger seat insert and footplates. Call your authorized Sunrise supplier for details. Use a torque setting of 100 in.-lbs. when making this adjustment.

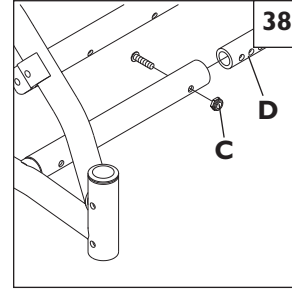

Y. FOLDING THE CHAIR 39

NOTE- Only chairs with cross brace assembly will fold.

1. To fold the chair, remove the seat and back.
2. Pull the cross brace strap (A) up.
3. Press the side frames together firmly.
4. To open the chair, extend fingers and apply even pressure with palm of hand directly on cross brace until it is fully extended.
5. Replace the seat and back.
6. To avoid pinching, be careful when folding or unfolding a chair.

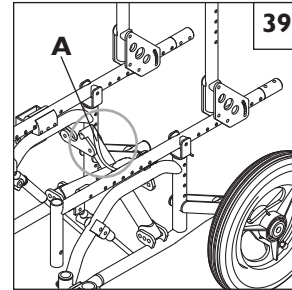

Z. GROWING SEAT PAN (optional) 40 41

1. Removing and Attaching the Seat Pan 40

- a) To remove, grasp front of seat pan (A) and firmly pull upward until seat mounting clips (B) disengage from the frame.
- b) To reattach, position seat pan on frame rail as desired and push down firmly on seat pan where it is attached to the seat mounting clips. Be sure to engage all four clips on frame rails.

NOTE- Rear of seat pan will be labeled.

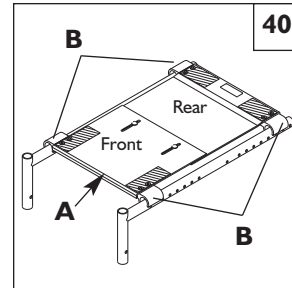

⚠ WARNING

Check for engagement by pulling up lightly on seat pan. It should not move upward. Failure to check for engagement may lead to injury if the seat mounting clips are not fully seated.

2. Adjusting Seat Pan Width 41

- a) Remove the two screws (A) that secure each seat mounting clip (B) to the seat pan.
- b) Position the seat mounting clips to the desired position, reattach the screws. Each hole is .5" apart for a total of 2" of width adjustment range.

NOTE- Tighten screws to 100 in.lbs. torque.

- c) Repeat steps "a" and "b" for each mounting clip.

NOTE- Both sides must be mounted to same hole position.

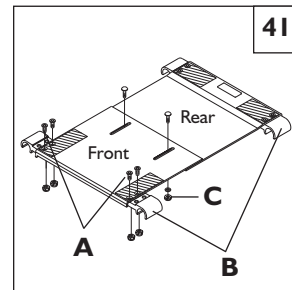

3. Adjusting Seat Pan Depth 41

- a) Loosen the two lock nuts (C) on under side of seat pan that attach the front seat pan panel to rear seat pan panel.
- b) Reposition seat pan to the desired length, and reattach the lock nuts.

NOTE- Tighten lock nuts to 100 in. lbs. torque.

AA. CHECK-OUT

After the wheelchair is assembled and adjusted, it should roll smoothly and easily. All accessories should also perform smoothly. If you have any problems, follow these procedures:

- a) Review assembly and adjustment sections to make sure chair was properly prepared.
- b) Review troubleshooting guide.
- c) If your problem persists, contact your authorized Sunrise supplier. If you still have a problem after contacting your authorized Sunrise supplier, contact Sunrise customer service. See the introduction page for details on how to contact your authorized Sunrise supplier or Sunrise customer service.

You will need to adjust your chair from time to time for best performance (especially if you alter the original settings). This chart gives you a first solution, then a second and a third if needed. You may need to look farther to find the best solution for a specific problem.

NOTE– To keep track of your progress, make only *ONE* change at a time.

SYMPTOMS	SOLUTIONS					
	Left Turn In Chair	Right Turn In Chair	Looseness In Chair	Sluggish Turning	Squeaks And Rattles	Caster Flutter
✓	✓	✓	✓			Make sure tire pressure is correct and equal in both rear tires and front caster tires, if pneumatic.
		✓	✓	✓	✓	Make sure all nuts and bolts are snug.
		✓		✓		Make sure all spokes and nipples are tight on radial spoke wheels.
				✓		Use Tri-Flow Lubricant (Teflon®-based) between all modular frame connections and parts.
✓	✓		✓		✓	Check for proper caster plate adjustment. See instructions for caster plate adjustment.
	✓					Add a spacer washer between the plastic saddle and the caster plate on the top of the left caster plate.
✓						Add a spacer washer between the plastic saddle and the caster plate on the top of the right caster plate.
✓						Add a spacer washer between the plastic saddle and the caster plate on the bottom right caster plate retaining bolts.
	✓					Add a spacer washer between the plastic saddle and the caster plate on the bottom right caster plate retaining bolts.
✓	✓		✓			Make sure there is an equal number of camber washers on each axle plate.
✓	✓				✓	Make sure both front casters touch the ground simultaneously. If they do not, add the proper spacers between the bottom bearing of the caster plate and fork stem nut until they do. Make sure you check for this problem on a flat surface.

A. INTRODUCTION

1. Proper maintenance will improve performance and extend the useful life of your chair.
2. Clean your chair regularly. This will help you find loose or worn parts and make your chair easier to use.
3. Repair or replace loose, worn, bent or damaged parts **before using this chair.**
4. To protect your investment, have all major maintenance and repair work done by your authorized supplier.

B. MAINTENANCE CHART

CHECK...	Weekly	3 Months	6 Months	Annually
Tire inflation level	✓			
Wheel locks	✓			
All fasteners for wear and tightness			✓	
Armrests				✓
Axle and axle sleeves				✓
Quick-Release Axles			✓	
Wheels, tires and spokes			✓	
Casters			✓	
Anti-tip tubes			✓	
Frame				✓
Upholstery			✓	
Service by Authorized Supplier				✓

C. MAINTENANCE TIPS

1. Axles & Axle Sleeves:

Check axles and axle sleeves every six months to make sure they are tight. Loose sleeves will damage the axle plate and will affect performance.

2. Tire Air Pressure:

Check air pressure in pneumatic tires at least ONCE A WEEK. The wheel locks will not grip properly if you fail to maintain the air pressure shown on tire sidewall.

D. CLEANING

1. Paint Finish

- a. Clean the paint finish with mild soap at least once a month.
- b. Protect the paint with a coat of non-abrasive auto wax every three months.

2. Axles and Moving Parts

- a. Clean around axles and moving parts WEEKLY with a slightly damp (not wet) cloth.
- b. Wipe off or blow away any fluff, dust, or dirt on axles or moving parts.

NOTE– You do not need to grease or oil the chair.

3. Upholstery

- a. Hand-wash (machine washing may damage fabric).
- b. Drip-dry only. DO NOT machine dry as heat will damage fabric.

E. STORAGE TIPS

1. Store your chair in a clean, dry area. If you fail to do so, parts may rust or corrode.
2. Before using your chair, make sure it is in proper working order. Inspect and service all items on the “Maintenance Chart.”
3. If stored for more than three months, have your chair inspected by an authorized supplier before use.

A. FOR LIFETIME

Sunrise warrants the frame and cross brace if applicable of this wheelchair against defects in materials and workmanship for the life of the original purchaser.

The expected life of this frame is five years.

B. FOR ONE (1) YEAR

We warrant all Sunrise-made parts and components of this wheelchair against defects in materials and workmanship for one year from the date of first consumer purchase.

C. LIMITATIONS

1. We do not warrant:
 - a. Tires and tubes, upholstery, pads and push-handle grips.
 - b. Damage from neglect, accident, misuse, or from improper installation or repair.
 - c. Products modified without Sunrise Medical's express written consent.
 - d. Damage from exceeding the weight limit.
2. This warranty is VOID if the original chair serial number tag is removed or altered.
3. This warranty applies in the USA only. Check with your supplier to find out if international warranties apply.
4. This warranty is not transferable and only applies to the first consumer purchase of this wheelchair through an authorized Sunrise Medical dealer.

D. WHAT WE WILL DO

Our sole liability is to repair or replace covered parts. This is the exclusive remedy for consequential damages.

E. WHAT YOU MUST DO

1. Obtain from us, while this warranty is in effect, prior approval for return or repair of covered parts.
2. Return the wheelchair or part(s), freight pre-paid, to Sunrise Mobility Products Division at: 2842 Business Park Avenue, Fresno, CA 93727-1328.
3. Pay the cost of labor to repair, remove or install parts.

F. NOTICE TO CONSUMER

1. If allowed by law, this warranty is in place of any other warranty (written or oral, express or implied, including a warranty of merchantability, or fitness for a particular purpose).
2. This warranty gives you certain legal rights. You may also have other rights that vary from state to state.

Record your serial number here for future reference:

Sunrise Medical Inc.
7477 East Dry Creek Parkway
Longmont, Colorado 80503
USA
(800) 333-4000
In Canada (800) 263-3390
www.sunrisemedical.com

Sunrise Medical Limited
High Street Wollaston
West Midlands DY8 4PS
England
Phone: +44 (0) 13 84 44 66 88
www.sunrisemedical.com



www.sunrisemedical.com

©2009 Sunrise Medical Inc. 10.09
930575 Rev. C