

H (Height)
 LF (Chest Height)
 SH (Groin height)
 User weight

Features included in standard price:

- Frame
- Locking casters
- Center bar
- Easy crank tilt system

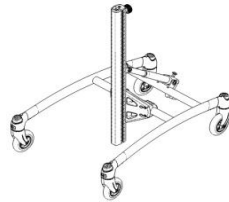

Size 2 grows to size 3
 Size 4 grows to size 5

Measurements

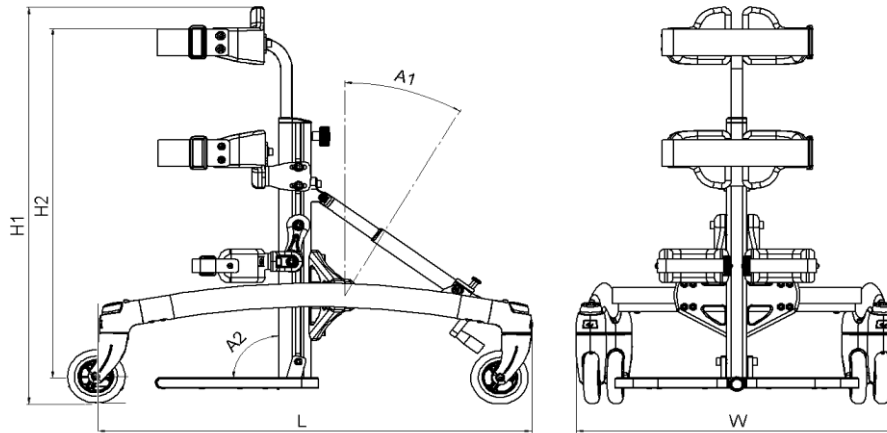

| | Size 1 | Size 2 | Size 3 | Size 4 | Size 5 |
|--------------------------|--------------|--------------|--------------|--------------|--------------|
| Length (L) | 29¼" | 34¼" | 34¼" | 43¼" | 43¼" |
| Width (W) | 21¾" | 24½" | 24½" | 27¼" | 27¼" |
| Total height (H1) | 26¼-34" | 28-39½" | 37¾-48" | 40½-52¼" | 48¼-60" |
| Hgt from foot/chest (H2) | 13¼-27¼" | 21-35" | 29-43" | 35½-47¼" | 43¼-55" |
| (H2) hgt w/ extension | 16¼-30¼" | 24-38" | 32-46" | 38½-50¼" | 46¼-58" |
| Floor to foot plate min. | 2¼" | 2¼" | 2¼" | 2½" | 2½" |
| Angle of center bar (A1) | 0° to +30° | 0° to +30° | 0° to +30° | 0° to +20° | 0° to +20° |
| Angle of footplate (A2) | +15° to -10° | +15° to -10° | +15° to -10° | +15° to -10° | +15° to -10° |
| Max. user weight | 67 lb | 89 lb | 111 lb | 132 lb | 154 lb |
| Product weight | 16,5 lb | 19 lb | 20 lb | 23 lb | 24 lb |

Account No. _____ Drop Ship: _____
 Date: _____ Name _____
 P.O. Number: _____ Address _____
 Buyer: _____ City _____
 Marked For: _____ State _____ Zip _____
 E Mail: _____ Tel. _____ Fax _____

Phone: 1-800-336-7684 Fax: 704-882-0751 www.snugseat.com PO Box 1739 Matthews, NC 28106

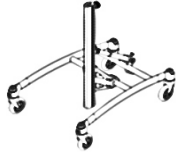
| | Description | Size | Part No. | CDN - Price |
|-----------------------------------------------------------------------------------|-----------------------------|------|----------|--------------------------------|
|  | Toucan Standing frame, red | 1 | 861001 | 1,640 <input type="checkbox"/> |
| | Toucan Standing frame, blue | 2 | 861002 | 1,640 <input type="checkbox"/> |
| | Toucan Standing frame, blue | 3 | 861003 | 1,640 <input type="checkbox"/> |
| | Toucan Standing frame, blue | 4 | 861004 | 1,825 <input type="checkbox"/> |
| | Toucan Standing frame, blue | 5 | 861005 | 1,825 <input type="checkbox"/> |

Accessories

| | | | | |
|------------------------------------------------------------------------------------|-----------------------------------------------|-----|--------|------------------------------|
|  | Chest support, size 1 bar, size 2/3 chest pad | 1 | 861704 | 275 <input type="checkbox"/> |
| | Chest support, Height & Width Adjustable | 2+3 | 861702 | 275 <input type="checkbox"/> |
| | Chest support, Height & Width Adjustable | 4+5 | 861703 | 310 <input type="checkbox"/> |

| | | | | |
|-------------------------------------------------------------------------------------|------------------------------------------------------------|--|--------|------------------------------|
|  | Filler Pad, small - adds 1" expansion to chest or hip pads | | 861421 | 100 <input type="checkbox"/> |
| | Filler Pad, large - adds 2" expansion to chest or hip pads | | 861422 | 100 <input type="checkbox"/> |

| | | | | |
|-------------------------------------------------------------------------------------|----------------------------------|-----------|--------|------------------------------|
|  | Extension for center profile, 3" | all sizes | 861480 | 110 <input type="checkbox"/> |
|-------------------------------------------------------------------------------------|----------------------------------|-----------|--------|------------------------------|



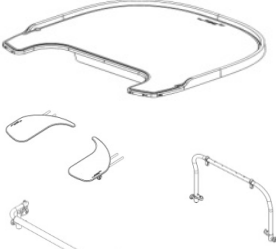



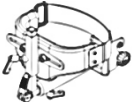

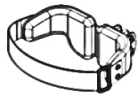

| | | | | |
|-------------------------------------------------------------------------------------|-----------------------|----------|--------|------------------------------|
|  | Tray with storage box | one size | 862501 | 495 <input type="checkbox"/> |
|-------------------------------------------------------------------------------------|-----------------------|----------|--------|------------------------------|

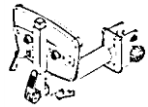
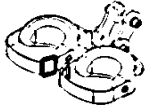
| | | | | |
|-------------------------------------------------------------------------------------|------------------------------|-----------|--------|------------------------------|
|  | Tray with bowl and top plate | 1 | 861121 | 700 <input type="checkbox"/> |
| | Tray with bowl and top plate | 2 | 861122 | 700 <input type="checkbox"/> |
| | Tray with bowl and top plate | 3 | 861123 | 700 <input type="checkbox"/> |
| | Tray with bowl and top plate | 4 | 861124 | 700 <input type="checkbox"/> |
| | Tray with bowl and top plate | 5 | 861125 | 700 <input type="checkbox"/> |
| | Armrests - Mount on Tray | all sizes | 861131 | 195 <input type="checkbox"/> |
| | Toybar | all sizes | 861135 | 295 <input type="checkbox"/> |
| | Grip Handle | all sizes | 861136 | 450 <input type="checkbox"/> |

| | | | | |
|-------------------------------------------------------------------------------------|-------------------|----------|--------|------------------------------|
|  | Abdominal support | one size | 861411 | 200 <input type="checkbox"/> |
|-------------------------------------------------------------------------------------|-------------------|----------|--------|------------------------------|

| | | | | |
|-------------------------------------------------------------------------------------|------------------------------------------|-----|--------|------------------------------|
|  | Hip support, w/pommel, Height Adjustable | 1 | 861501 | 695 <input type="checkbox"/> |
| | Hip support w/pommel, Hgt and Wdt Adj | 2+3 | 861502 | 695 <input type="checkbox"/> |
| | Hip support w/pommel, Hgt and Wdt Adj | 4+5 | 861503 | 695 <input type="checkbox"/> |

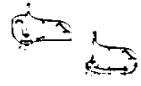
All hip supports include a strap

| | Description | Size | Part No. | CDN - Price |
|-------------------------------------------------------------------------------------|-------------------------------------------------------------------|-----------|----------|------------------------------|
|  | Hip support, front mount, Height Adjustabl | 1 | 861601 | 310 <input type="checkbox"/> |
| | Hip support, front mount, Hgt & Wdt Adj | 2+3 | 861602 | 310 <input type="checkbox"/> |
| | Hip support, front mount, Hgt & Wdt Adj | 4+5 | 861603 | 330 <input type="checkbox"/> |
|  | Hip support, rotational, Height Adjustable | 1 | 861611 | 465 <input type="checkbox"/> |
| | Hip support, rotational, Hgt & Width Adj | 2+3 | 861612 | 465 <input type="checkbox"/> |
| | Hip support, rotational, Hgt & Width Adj | 4+5 | 861613 | 495 <input type="checkbox"/> |
|  | Pommel and sacral support | one size | 861401 | 585 <input type="checkbox"/> |
|  | Knee supports, including straps, set | 1 | 861301 | 355 <input type="checkbox"/> |
| | Knee supports, including straps, set | 2+3 | 861302 | 465 <input type="checkbox"/> |
| | Knee supports, including straps, set | 4+5 | 861303 | 465 <input type="checkbox"/> |
|  | Hinged knee supports, including straps, set | 1 | 861311 | 565 <input type="checkbox"/> |
| | Hinged knee supports, including straps, set | 2+3 | 861312 | 565 <input type="checkbox"/> |
| | Hinged knee supports, including straps, set | 4+5 | 861313 | 565 <input type="checkbox"/> |
|  | Flip up footplate | 1 | 861211 | 275 <input type="checkbox"/> |
| | Flip up footplate | 1 - 5 | 861212 | 275 <input type="checkbox"/> |
| <u>FOOTPLATE ACCESSORIES - Require Flip up foot plate</u> | | | | |
|  | Shoe holders for flip up footplate | 8¼" x 3¾" | 86147 | 190 <input type="checkbox"/> |
| | Shoe holders for flip up footplate | 9¼" x 4½" | 86148 | 190 <input type="checkbox"/> |
| | Footstraps, plastic lock | one size | 36-8596 | 65 <input type="checkbox"/> |
|  | Hinged sandals (flip up footplate), w/ straps | 1 | 861221 | 180 <input type="checkbox"/> |
| | Hinged sandals (flip up footplate), w/ straps | 2+3 | 861222 | 180 <input type="checkbox"/> |
| | Hinged sandals (flip up footplate), w/ straps | 4+5 | 861223 | 190 <input type="checkbox"/> |
|  | Individual footrests with hinged sandal | 1 | 861201 | 495 <input type="checkbox"/> |
| | Individual footrests with hinged sandal <i>Includes straps</i> | 2+3 | 861202 | 495 <input type="checkbox"/> |
|  | Heel stop | small | 861251 | 75 <input type="checkbox"/> |
| | Heel stop | large | 861252 | 75 <input type="checkbox"/> |
|  | Center Profile (Grows size 2 to size 3) | | 861903 | 170 <input type="checkbox"/> |
| | Center Profile (Grows size 4 to size 5) | | 861905 | 220 <input type="checkbox"/> |

| Description | Size | Part No. | CDN - Price |
|-------------|------|----------|-------------|
|-------------|------|----------|-------------|

All headrests require a Swing-away Mounting Bracket and Headrest Style



| | | | |
|----------------------------------------------------------------|-----------|----------|------------------------------|
| Swing-away Bracket - Height, Depth, Angle & Lateral Adjustable | | | |
| Mounting for Head support | 1 & 2 | 861424-1 | 475 <input type="checkbox"/> |
| Mounting for Head support | 3, 4, & 5 | 861424-2 | 475 <input type="checkbox"/> |



| | | | |
|---------------------------------------------------|--|---------|------------------------------|
| Head support no. 1 | | 6171550 | 290 <input type="checkbox"/> |
| Head support no. 2 | | 6172550 | 290 <input type="checkbox"/> |
| Head support no. 3 | | 6173550 | 290 <input type="checkbox"/> |
| Head support no. 4 | | 6174550 | 290 <input type="checkbox"/> |
| Anatomic head support*, Small - A = 3", B = 8" | | 5099001 | 325 <input type="checkbox"/> |
| Anatomic head support*, Medium - A = 3", B = 10¼" | | 5099002 | 325 <input type="checkbox"/> |
| Anatomic head support*, Large - A = 4¼", B = 13" | | 5099003 | 325 <input type="checkbox"/> |
| <i>*Includes black Ducutex cover</i> | | | |



| | | | |
|-------------------------------------------------------|--|---------|------------------------------|
| Headband System (For Anatomic Head Support only) | | 99500 | 295 <input type="checkbox"/> |
| Extra headband strap (For Anatomic Head Support only) | | 99400-5 | 75 <input type="checkbox"/> |

All of the above Head Supports are Black Polyurethane



| | | | |
|---------------------------------------------------------------|--|-------------|------------------------------|
| Adjustable Width Headrest, large laterals, without speakers** | | 99737XX-85 | 325 <input type="checkbox"/> |
| Speakers for Adjustable Width Headrest, large laterals | | X99717XX-85 | 125 <input type="checkbox"/> |
| <i>**Includes black Mesh cover</i> | | | |

Spare Parts

| | | | |
|--------------------------------------------|-----|--------|------------------------------|
| Strap for hip support | 1 | 861621 | 67 <input type="checkbox"/> |
| Strap for hip support | 2+3 | 861622 | 67 <input type="checkbox"/> |
| Strap for hip support | 4+5 | 861623 | 67 <input type="checkbox"/> |
| Straps for knee support, set | 1 | 861341 | 62 <input type="checkbox"/> |
| Straps for knee support, set | 2+3 | 861342 | 62 <input type="checkbox"/> |
| Straps for Flip up foot plate sandals, set | 1 | 861241 | 103 <input type="checkbox"/> |
| Straps for Flip up foot plate sandals, set | 2+3 | 861242 | 103 <input type="checkbox"/> |
| Straps for Flip up foot plate sandals, set | 4+5 | 861243 | 103 <input type="checkbox"/> |

NOTES