

the **COMPLETE SOLUTION**

ONE CALL DOES IT ALL . . . *one order form | one purchase order | one invoice*



The Complete Solution



perfectly
POSITIONED

Full Line of Motion Concepts
Power Positioning
& Invacare® MatrX® Seating

lighted
FENDERS

Optional LED Front & Rear
Fender Safety Lights



The all new MWD* ROVI X3 Power Base is the perfect complement to Motion Concepts' full line of innovative power positioning products and industry leading Invacare® MatrX® Seating Solutions!

* Mid Wheel Drive

BASE

HCPC CODES	K0848, K0849, K0856, K0861
SUSPENSION SYSTEM	Active Ride Control (ARC)
BASE WIDTH	23.25"
BASE LENGTH	36.5"
SEAT-TO-FLOOR HEIGHT	as low as 17"
DRIVE WHEEL SIZE ⁽¹⁾	14"
CASTER WHEEL SIZE (front/rear)⁽¹⁾	6"
TURNING RADIUS	20"
DRIVETRAIN	4-pole EAD Motors

BATTERIES	2 x M34
	3 x M40 option for Vents
BATTERY CHARGER	8A, Off Board
BATTERIES WEIGHT (each)	42 lbs
RANGE ⁽²⁾	17.7 miles
WEIGHT CAPACITY	300 lbs
BASE WEIGHT	157 lbs
GROUND CLEARANCE	3"
MAXIMUM SPEED	5 mph

FENDER COLORS



⁽¹⁾ All X3 wheels come with solid inserts

⁽²⁾ Actual driving range and speed may vary due to factors such as user weight, type and grade of terrain, battery condition & charge level; type and condition of the drive wheels, and variations in the drive and control systems.

ULTRA LOW MAXX POWER POSITIONING SYSTEM

POWER POSITIONING SYSTEMS	SYSTEM DESCRIPTION	HCPC CODE
ULTRA LOW MAXX CG TILT ONLY SYSTEM	up to 50°	E1002
ULTRA LOW MAXX CG TILT AND RECLINE SYSTEM WITH ESR	up to 50° Tilt, 170° Recline with (ESR) Extended Shear Reduction	E1007
ULTRA LOW MAXX CG TILT AND RECLINE SYSTEM WITH PSB	up to 50° Tilt, 170° Recline with (PSB) Power Sliding Back	E1008
ULTRA LOW MAXX RECLINE SYSTEM WITH ESR	170° Recline with (ESR) Extended Shear Reduction	E1004
ULTRA LOW MAXX RECLINE SYSTEM WITH PSB	170° Recline with (PSB) Power Sliding Back	E1005
ULTRA LOW MAXX ELEVATING LIFT SEAT ONLY SYSTEM	12" of Power Seat Elevation	
SEAT WIDTH	11" - 24" width adjustment ranges 11"-15" ⁽¹⁾ , 16" - 20", 19" - 22"	
SEAT DEPTH	11" - 22" depth adjustment ranges 11"-15" ⁽¹⁾ , 16" - 20", 19" - 23"	
ADDITIONAL MODULES	Recline Body Fit; Power Anterior Tilt up to 45°; 5° & 10° Fixed Anterior Assist; 5° Pre-Tilt; 8° or 30° Precline; Single Post Angle Adjustable Fold Down Back; Single Post Manual Recline Back	

⁽¹⁾ Pediatric Seat sizes offer up to 50° of CG Tilt, 165° of Recline and Seat-to-floor is increased by 1"

MATRIX SEATING SOLUTIONS

BACK	CONTOUR	WIDTH	HEIGHT	HCPC CODE	CUSHION	WIDTH	WIDTH	HCPC CODE
MINI	3"	10" - 14"	7", 10", 12"	E2615	KID*AB*RA	12" - 14"	12" - 14"	E2607
ELITE	3"	12" - 20"	10", 12" 14", 16", 18", 20"	E2620	VI	14" - 22"	12" - 14"	E2607, E2608
ELITE HD	3"	21" - 22"	16", 20"	E2620, E2621	PS	16" - 22"	12" - 14"	E2605, E2606
ELITE TR	3"	15" - 20"	16", 18", 20"	E2620	LIBRA	16" - 22"	12" - 14"	E2624, E2625
ELITE TR HD	3"	15" - 20"	16", 18", 20"	Pending	FLO-TECH	15" - 22"	12" - 14"	E2622
ELITE DEEP	6"	14" - 20"	10", 12" 16", 18", 20"	E2620				
ELITE DEEP HD	6"	14" - 20"	10", 12" 16", 18", 20"	Pending				
PB	5"	14" - 20"	12" 16", 20"	E2615				
PB DEEP	7"	14" - 20"	12" 16", 20"	E2615				
PB HD	5"	20" - 22"	16", 20"	E2615, E2616				
PB HD DEEP	7"	20" - 22"	16", 20"	E2615, E2616				

We keep up with the most active lifestyles!

unique
IN-LINE BATTERY CONFIGURATION

Offers unmatched stability and performance

ROVI Pronunciation: [roh*vee]

From the root word Roving:

“Not restricted as to location or area, capable of moving from place to place”

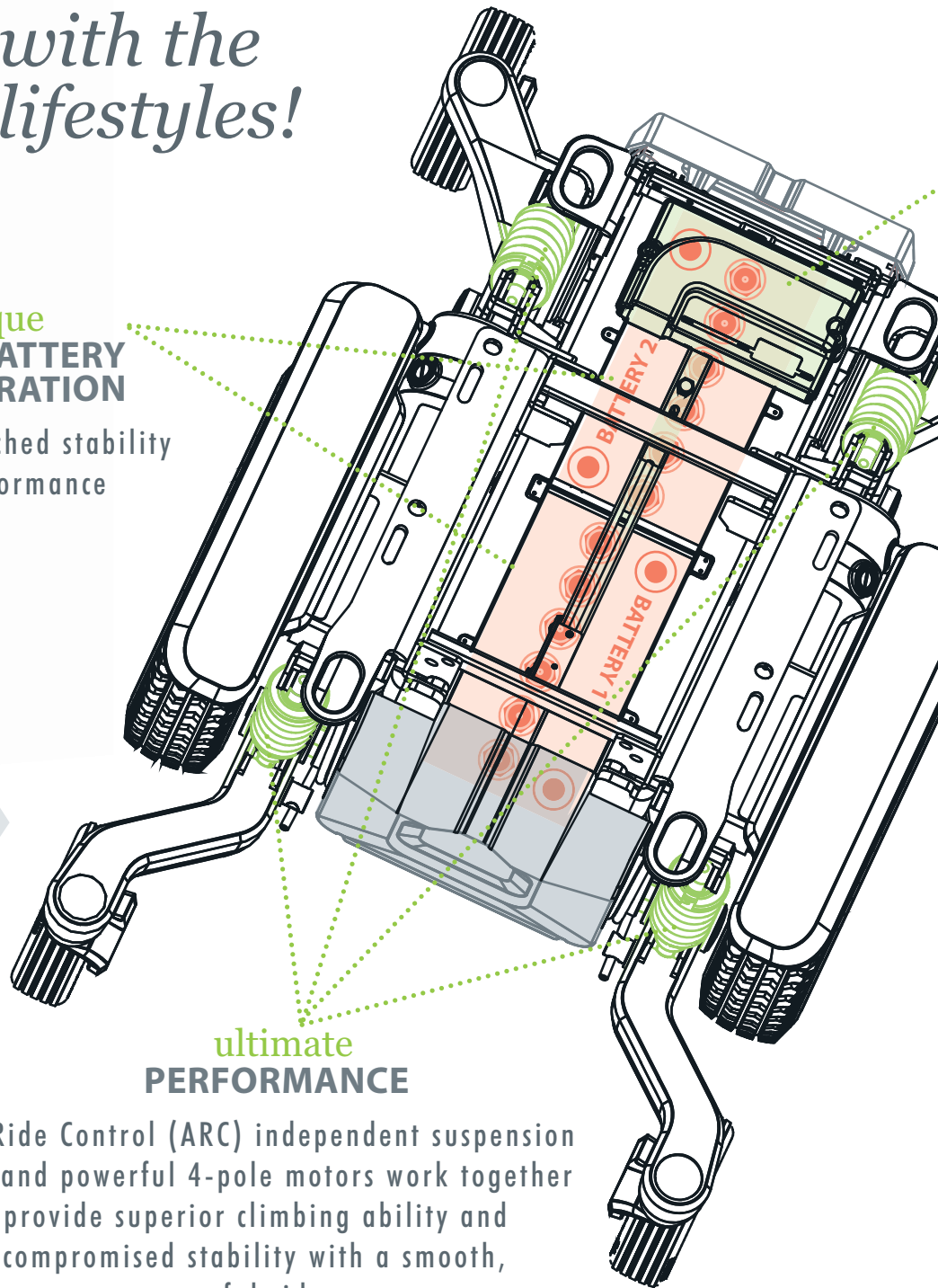

ultimate
PERFORMANCE

Active Ride Control (ARC) independent suspension system and powerful 4-pole motors work together to provide superior climbing ability and uncompromised stability with a smooth, powerful ride.

optimal
BALANCE

The ROVI X3's unique frame configuration optimizes weight distribution by concentrating the mass through the midline of the power base. This revolutionary configuration provides clients with the industry's narrowest power base without sacrificing stability or performance.



the
BRAIN

Easily accessible
Drive Control Module

total
CONTROL

The ROVI X3 utilizes well-known PG Drives Technology. This electronics platform delivers both non-expandable and expandable control options with numerous innovative features. ROVI chose this platform for its industry-leading performance, reliability, and ease of programming. The ROVI X3's standard 4-pole motors have been precision matched for peak performance with PG Drives.



complete
PACKAGE

PG Electronics:
Performance, Reliability and
Ease of Programming



More than just another pretty face

From inception, Motion Concepts and ROVI have worked side-by-side to create a truly exceptional wheelchair design. Both companies are driven by years of experience and a mutual passion to further our clients' independence, comfort and function. The result of this extraordinary partnership is a power base that blends together outstanding performance and stability with the best power positioning system on the market.

customizable **FENDERS**

- U.S. Military Branch designs
- Customer inspired designs





transport FRIENDLY

- Single Post Angle Adjustable Fold Down Back
- 4-Point Tie Down brackets
- EZ Lock & Q'Straint Ready

new HEIGHTS

- 12" of Power Seat Elevation, Tilt and Recline
- Seat-to-Floor Heights as low as 17"



compact FOOTPRINT

- Mid Wheel Drive for ultimate maneuverability
- Unique Battery configuration for optimal lower extremity positions
- Decreased overall functional length





Good things come in small packages



The unique chassis design and narrow footprint makes ROVI X3 a perfect fit for the power mobility needs of children. The ROVI X3's small size performs extremely well in narrow indoor spaces, and its blend of power and ARC suspension offers optimum performance and stability for active kids in a variety of outdoor applications. When outfitted with Motion Concepts' modular Ultra Low Maxx Pediatric Power Positioning System and Invacare® MatrX® Mini Seating Series, the ROVI X3 becomes the ultimate power solution for kids!

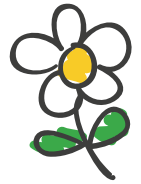
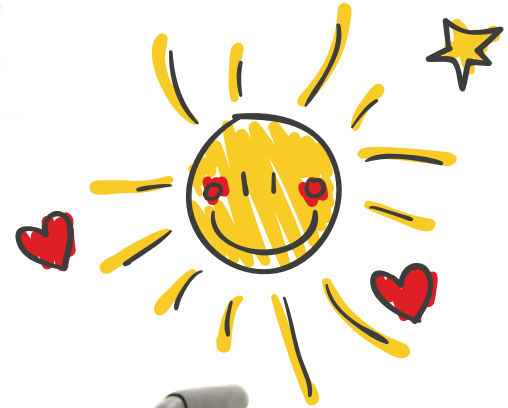

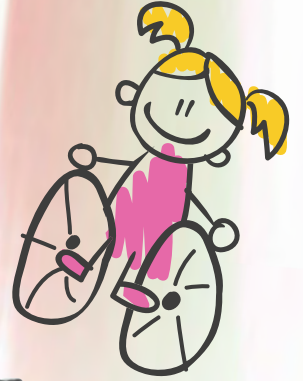

mini
PACKAGE
Motion Concepts Power
Positioning
& Invacare® MatrX®
Seating

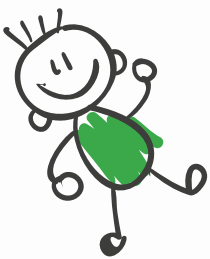

A whole new level of service access

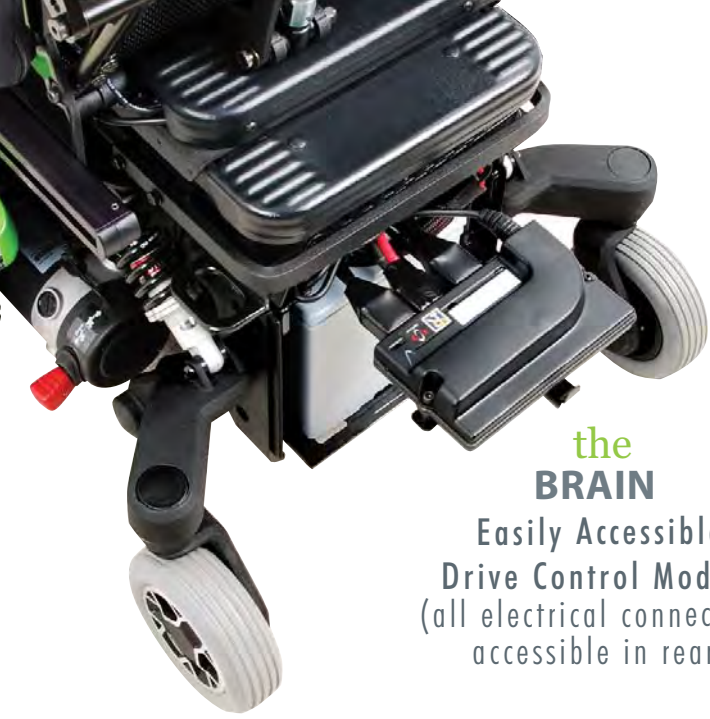

the BRAIN

Easily Accessible
Drive Control Module
(all electrical connections
accessible in rear)

the HEART

- M270 Attendant Power Positioning Programmer & Controller
- Complimentary ROVI USB Charger



The ROVI X3 was created with a fresh approach to service access. Making service and functional adjustments easier and more simplistic was one of our key goals. From the new M270 attendant and programmer, to the slide-out design of the ROVI X3's power module, all of our elegantly designed features take service access and adjustability to a whole new level!



**totally
ACCESSIBLE**
Fore-and-aft
adjustment

**unique
BATTERY
CONFIGURATION**

Replace batteries in two easy steps:
Front & Rear access

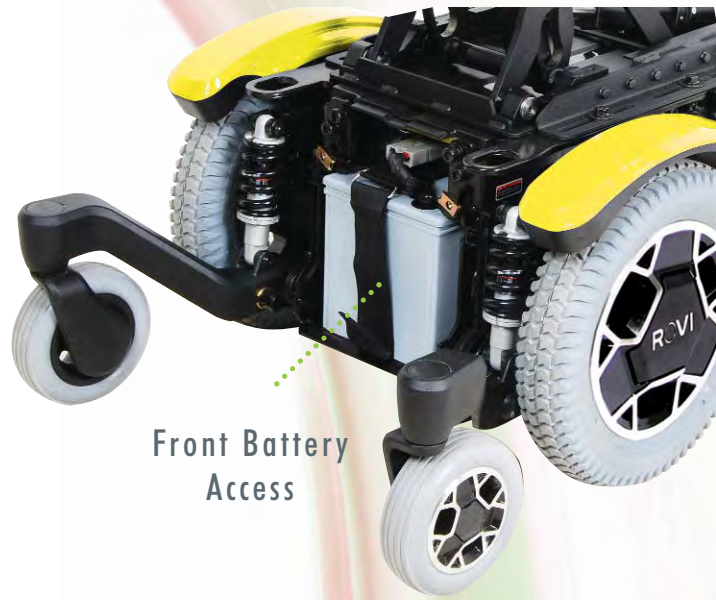

Front Battery Access

**service
FRIENDLY**

Extended Shear Reduction (ESR) Shear Adjustment Link



*Rear shroud removed

Connections for R-Net, 6 Channel & Joystick

6 Channel Seat Controller

Drive Control Module

Rear Battery Access

George is a retired electrical engineer who loves to garden and keep up with the latest technology. In his younger days, you could often find George cruising around on his motorcycle or outdoors camping with his friends. Although George has been living with Multiple Sclerosis for nearly 20 years now, it certainly hasn't slowed him down or kept him away from the things he enjoys most. These days, George is able to keep up with his grandchildren and tend to his many plants thanks to the mobility and comfort provided by his ROVI X3 Maxx wheelchair and Matrix seating products.



Follow us on . . .



Toll Free Tel: 1.888.433.6818 ► Toll Free Fax: 1.888.433.6834 ► www.motionconcepts.com