

# VERTIFLEX 60

SYSTEMS

## USER MANUAL



Synetik  
ErgoCare



# ABOUT THE PRODUCT

Synetik ErgoCare's patented Vertiflex 60 Standing Frame is designed to provide added positioning assistance to the user. Supports and pad dimensions are adjusted specifically to meet the anthropometric measurements provided by the therapist. This growth extension can be done at time of delivery of the standing frame to ensure a proper fit for the user.

The Synetik ErgoCare Vertiflex 60 Standing Frame enables the user to remain upright, facilitating blood circulation, digestion and muscle development. In addition, the abduction option further reinforces a user's lower limb capacity by reducing the risk of aggravating any hip problems which can be brought on by prolonged periods of sitting or lying down. Being in an upright position also allows the user to socialize more easily with their peers and tends to promote their physical and psychological development.

The Vertiflex-60 is easy to use in a variety of contexts and environments such as at home, in childcare settings as well as at school. The Vertiflex 60 can be used in either a prone or supine position. This standing frame is also available in a hybrid model, which offers both a prone and supine positioning capability within the same product.



## IMPORTANT

Read the User Guide carefully before using the device for the first time and keep the Guide for future reference.



## SAFETY INSTRUCTIONS

- The use of the Vertiflex 60 Standing Frame must follow the recommendation and adjustment by a specialized therapist.
- Ensure that all accessories used are approved by Synetik as recommended.
- Ensure that all persons handling the standing frame are familiar with its operation and have read the User Guide.
- Never leave the user unattended while in the device.
- Make sure all straps are securely fastened before standing the user up in the device.
- Never add any weight other than that of the user to prevent the equipment from tipping.
- Always lock the wheels when the device is not moving.
- Make sure the standing frame is on a smooth, level surface.
- Never move the equipment when the user is in it.
- Never attempt to modify the product. Use only parts approved by Synetik ErgoCare otherwise the safety of the user may be jeopardized, and the warranty will be voided.
- If unsure about the safe use of the product, stop using it and contact Customer Service.
- Some parts of the standing frame may be a choking hazard for children. Always make sure that parts are securely fastened to the product.

# ABOUT THE PRODUCT

- Never go down the stairs with a user in the product.
- Never use the stander on an escalator.
- Never go down the stairs with a user in the product.
- Never use the stander on an escalator. Never leave the product in the sun. Always check the temperature of the cushions and metal structure before placing the user in the standing frame.
- Always be sure to hold the product firmly before adjusting the angle of the stander.
- Never place hot items on the tray.
- Clean the product regularly, as per the cleaning instructions detailed below.
- Inspect the product regularly to ensure its proper operation.
- It is preferable to avoid leaving the Vertiflex 60 outside as it may be damaged by rain, snow or sun damage.
- Never use the standing frame for transport in a vehicle.



## CLEANING AND MAINTENANCE

An inspection of all moving parts, adjustment knobs and levers must be done regularly to avoid a decrease in adjustment tension. Please refer to Daily Inspection section for additional details on daily safety matters. To clean, use soapy water and a soft cloth.



## DECLARATION OF CONFORMITY

Synetik ErgoCare warrants and declares under its sole responsibility that the Vertiflex 60 Standing Frame complies with all applicable requirements.



## GUARANTEE

Synetik ErgoCare guarantees its products to the original purchaser for a period of two years if used appropriately and according to the recommendations. Synetik ErgoCare reserves the right to repair or replace any defective part, if need be.

**If you have any questions or comments, you can contact us via our website :**

synetikergocare.com or by phone: 450 752-8818, Toll-free: 1 888 752-8818

# ABOUT THE PRODUCT

## USER TRANSFER PROCEDURES

1. When helping a user in and out of the Vertiflex 60, make sure the product is properly positioned horizontally with wheels locked. Also make sure that the product is on an even, soft floor.
2. Once all supports (axilla, thoracic, hip and knee) are properly freed, install the user in the product (laying down) and then fix all supports to securely maintain the user.
  - a. Transfer of user in and out of product must be performed by a trained professional or authorized caregiver.
  - b. Transfer techniques might differ from one user to another based on their medical condition.

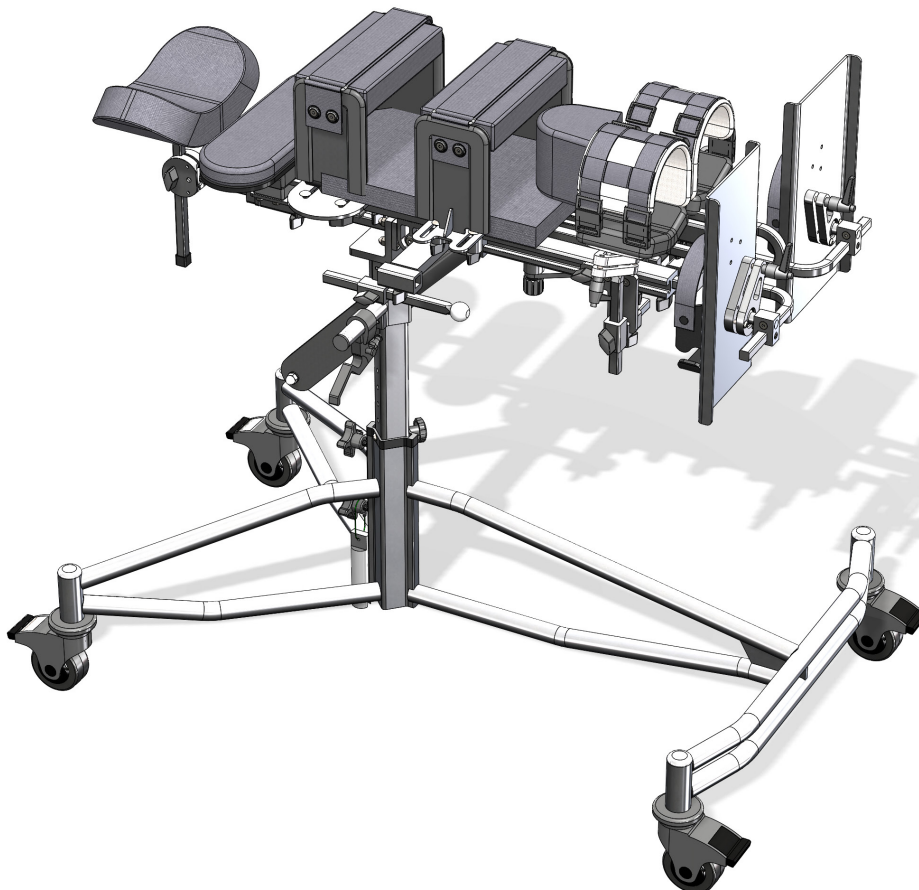

# ADJUSTMENT PROCEDURE

## 1. LOCKING THE WHEELS

Each of the four wheels has a brake. Make sure all wheels are locked when the standing frame is in use, being adjusted or stored (**fig. 1**).

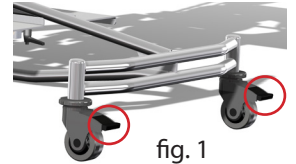

## 2. ASSEMBLING THE STANDING FRAME

To facilitate transporting the device, it is made in two parts. To separate the standing frame core from its base (**fig. 2b**), loosen the two knobs at the base. Lift the standing frame up so that it totally clears its base (**fig. 2a**). When assembling, tighten the two knobs securely. Always keep the device above the ring indicator to avoid injury.

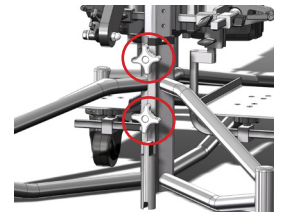

## 3. FOOT SUPPORT ADJUSTMENT

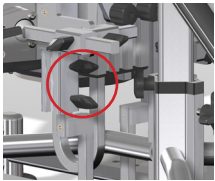

To adjust the height of the footrests, loosen the two knobs located behind the main support of the stander core (**fig. 3c**). Slide the footrest rod up or down to the desired height and retighten knobs securely to ensure that the weight of the user is well supported. To adjust the footrest width, you will need to use the Allen key located on the side of the hydraulic cylinder (**fig. 3e**).

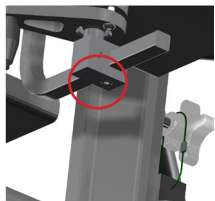
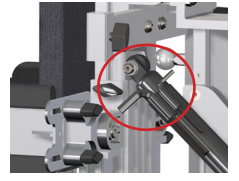

Loosen the set screw located under the block (beneath the footrest) (**fig. 3b**). Slide sideways to the desired width and then retighten with the Allen key. For angle adjustment of the footrest, use the adjustable lever (**fig. 3d**). To do this you will need to lift the lever slightly and then turn clockwise to tighten and counter-clockwise (by raising it) to reposition the lever in the proper place. Rotate the footrest plate to the desired position and retighten.



## 4. KNEE SUPPORT ADJUSTMENT

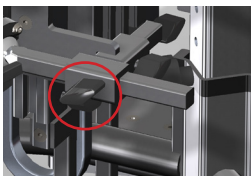

To adjust the depth of the knee supports, loosen the knob on the cross bar of the knee support (**fig. 4a**). Slide knee support to the required dimension and retighten securely. To adjust the height of the knee supports, loosen the two knobs on the side and behind the knee support (**fig. 4b**).



Slide knee supports to the required dimension and retighten securely. For angle adjustment of the knee supports, you will need to lift the lever slightly and then turn clockwise to tighten and counter-clockwise (by raising it) to reposition the lever in the proper place (**fig. 4d**).

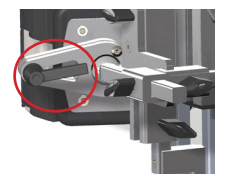

# ADJUSTMENT PROCEDURE

## 5. ABDUCTION ANGLE ADJUSTMENT

To adjust the abduction angle, loosen the two knobs on each side and gradually lift outward to the required position. Retighten both knobs on each side (**fig. 5a-b**).

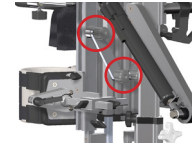

fig. 5a

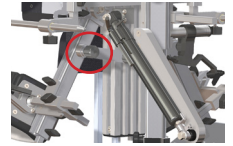

fig. 5b

## 6. POMMEL HEIGHT ADJUSTMENT

To adjust the height of the pommel you will need to use the Allen key located on the side of the hydraulic cylinder. Loosen the set screw located on the right side at the bottom of the stander core (**fig. 6**), then slide the pommel to the desired height. Use the Allen key to firmly retighten the set screw.



fig. 6

## 7. HIP SUPPORT ADJUSTMENT

To adjust the height of the hip supports, loosen the wing knob and the two other knobs located between the hip and knee supports (**fig. 7a**). Slide to the desired height and retighten the three knobs. To adjust the width of the hip supports, loosen both wing knobs. Slide to the required width, then retighten (**fig. 7b**).



fig. 7a

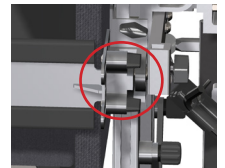

fig. 7b

## 8. THORACIC SUPPORT ADJUSTMENT

To adjust the height of the thoracic supports, loosen the two knobs located in the upper part of the core (**fig. 8a**). Slide the top part of the support up or down to the desired height and retighten. To adjust the width of the thoracic supports, loosen the two knobs on each side of the core and slide sideways to the required width (**fig. 8b**). Firmly retighten the four knobs.



fig. 8a

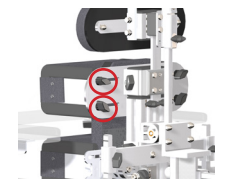

fig. 8b

## 9. SHOULDER SUPPORT ADJUSTMENT

To adjust the height of the shoulder support, use the Allen key and loosen the two set screws (**fig. 9**). Adjust by sliding to the desired height and retighten with the Allen key.



fig. 9

## 10. HEADREST ADJUSTMENT

To adjust the headrest height (upward), loosen the knob behind the shoulder rest, slide the rod upward, and retighten the knob (**fig. 10**). To lower the height of the headrest, proceed in the same way in addition to loosening the screw on the stopper ring with the Allen key.

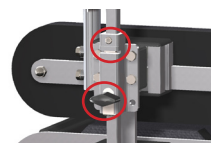

fig.10

# ADJUSTMENT PROCEDURE

## 11. TRAY ADJUSTMENT

To install the tray, insert the rods into the round glides located on the hip supports (**fig. 11a**). Angle the end of the tray upward to slide it in more easily, then release it at the desired position. The mechanism will then block the tray at this spot. For added safety, tighten the knob under the round glide to secure the tray into position (**fig. 11b**).



fig. 11a

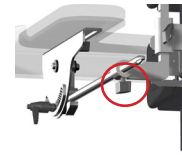

fig. 11b



fig.11f

To adjust the height of the tray, loosen the knob on each side behind the hip support (**fig. 11f**).

Slide up or down to the desired height and retighten. To adjust the tray angle, use the adjustable lever (**fig. 11c-d**). To do this you will need to raise the lever slightly and then turn clockwise to tighten and counter-clockwise (by raising it) to reposition the lever in the proper position.



fig. 11c



fig. 11d

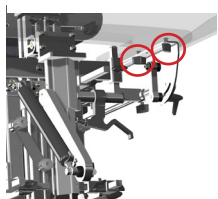

fig.11e

Rotate the tray to the desired angle and retighten the adjustable lever. For depth adjustment of the tray, loosen the two knobs on each side, located under the tray on the inner section of the angle adjustments (**fig. 11e**). Slide the tray on its glides to the desired location and retighten the four knobs.

## 12. STRAP ADJUSTMENT

Some supports are anchored using a Velcro strap to facilitate positioning of the user. Insert the strap into the metal loop and fold the Velcro closure (**fig. 12a**). In this way, the user will now be firmly and comfortably positioned. Also make sure that all cushions are centered once these adjustments are completed.

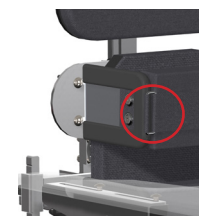

fig. 12 a

## 13. STANDING FRAME ANGLE ADJUSTMENT

To facilitate the transfer in or out of the standing frame or to optimize the comfort of the user, the angle can be adjusted on this device.

When making any changes to the angle, be sure to:

- Lock all the wheels before.
- Hold the device in place firmly, with one hand on the pivot handle while activating the cylinder activation lever with the other hand.



# ADJUSTMENT PROCEDURE

- Verify that no part of the user's body or that of the caregiver can be wedged or touched during the angle-change procedure.
- Check that all Velcro straps and other fasteners are in place and properly adjusted.
- Make sure the standing frame is at a proper distance away from any surrounding

To change the angle, hold the pivot handle firmly with one hand while activating the cylinder activation lever with your other hand (**fig. 13a**). To maintain positioning at a specific angle, simply release the activation lever at the desired angle. To maintain the user position at a certain angle, loosen the knob just above the cylinder activation lever and slide the round tipped rod to the desired position to keep the angle in place (**fig. 13b**). Retighten the knob.

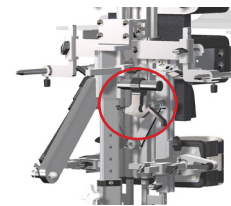

fig. 13a

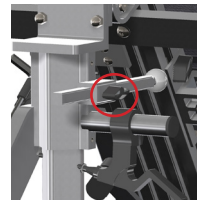

fig. 13b

NOTE - If you have difficulty in reaching it or tightening it securely, use the tightening tool provided for this purpose (**fig. 13c-d**).

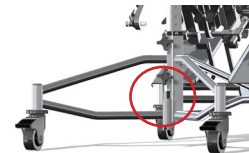

fig. 13c



fig. 13d

## PARTS REPLACEMENT PROCEDURES

If a part of the Vertiflex 60 is broken or missing, stop using the product and contact a Syntetik ErgoCare's authorized representative or your territory. Order of additional or replacement parts can be done through a Syntetik ErgoCare's authorized representative or via our customer service.

## DAILY INSPECTION OF VERTIFLEX 60 STANDING FRAME

Syntetik ErgoCare recommends that a daily visual inspection be performed by a therapist, parent or caregiver to ensure the safe use of the product. In order to perform the daily inspection of the Vertiflex 60 Standing Frame, you will need to:

- Check that all the knobs are in place and tight.
- Inspect the protective covers and straps to ensure there are no signs of wear.
- Make sure that the wheels turn freely and lock securely.
- Check that the footrest is firmly secured into position.

# SPECIFICATIONS

## SELECTION CHART

		BABY		KID		JUNIOR	
		Size: 24-39 in		Size: 34-50 in		Size: 45-72 in	
		Max weight: 50 lb		Max weight: 70 lb		Max weight: 150 lb	
		Minimum	Maximum	Minimum	Maximum	Minimum	Maximum
Height	Floor to hip	10	15	15	22	22	34
	Floor to knee	5	10	7	14	12	18
Width	Shoulder	-	10	8	12	10	20
	Axilla	5.5	10	5.5	14	5.5	18
	Knee	1.5	3.5	2.5	4	2.5	5.5
	Hip	5	12.75	5	12,75	5	17

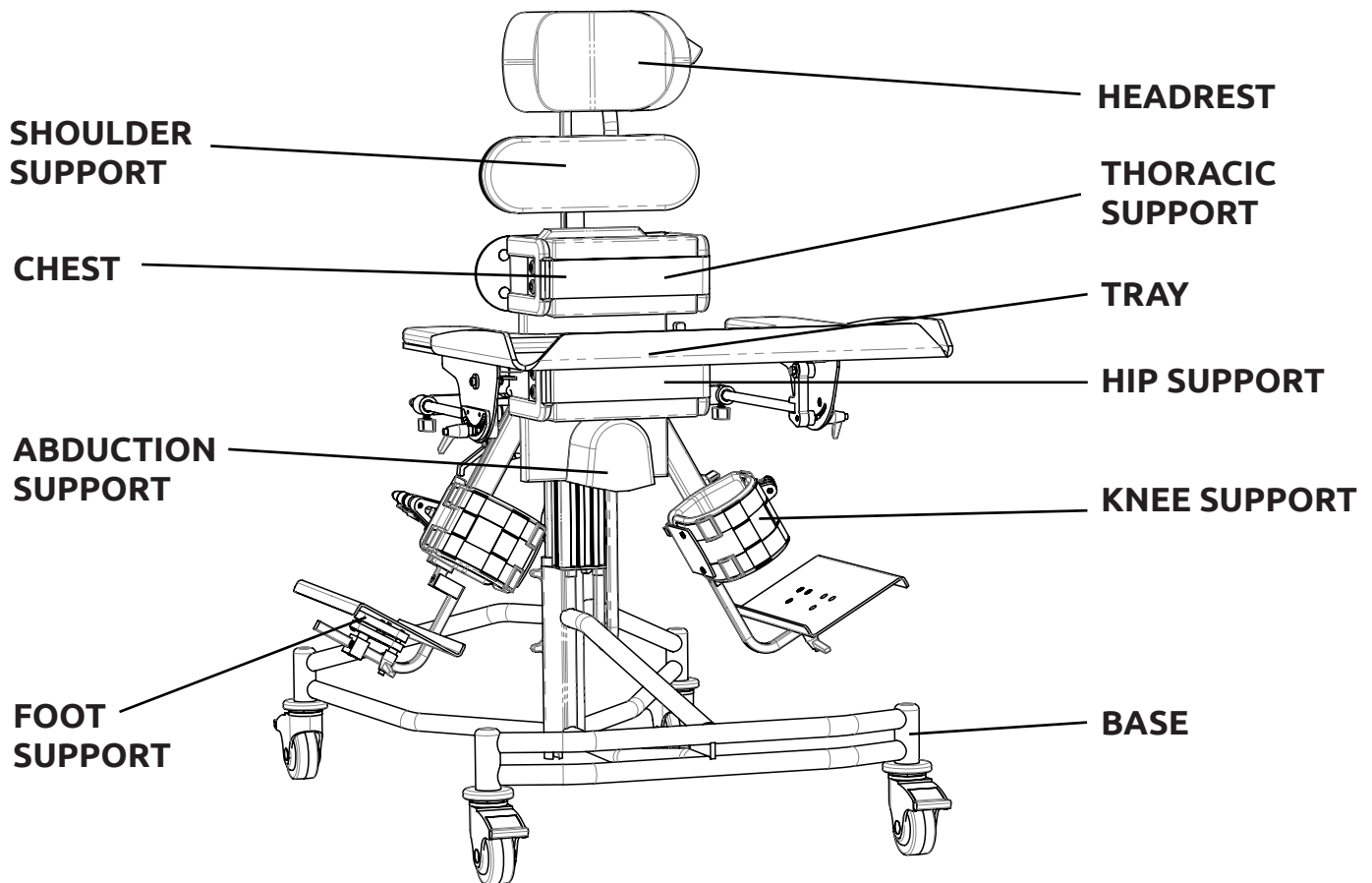

# PARTS

## ① HEADREST

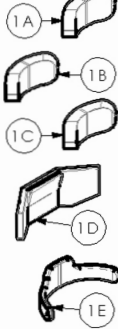

- 1A) RIGID**  
022-00002-4 (4" H.)  
022-00002-5 (5" H.)  
022-00002-6 (6" H.)
- 1B) SOFT**  
022-00001-4 (4" H.)  
022-00001-5 (5" H.)  
022-00001-6 (6" H.)
- 1C) SOFT AND SHAPEABLE**  
022-00004-4 (4" H.)  
022-00004-5 (5" H.)  
022-00004-6 (6" H.)
- 1D) MULTI-ANGLE ADJUSTABLE**  
022-00005-14 (4-1/2" H.)  
022-00005-16 (5" H.)  
022-00005-17 (5-1/2" H.)
- 1E) SHAPEABLE LATERALS**  
022-00003

## ② HEADREST MOUNT

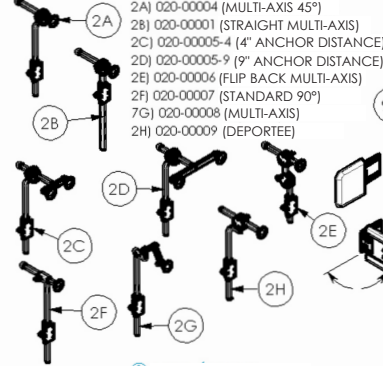

- 2A) 020-00004 (MULTI-AXIS 45°)**  
**2B) 020-00001 (STRAIGHT MULTI-AXIS)**  
**2C) 020-00005-4 (4" ANCHOR DISTANCE)**  
**2D) 020-00005-9 (9" ANCHOR DISTANCE)**  
**2E) 020-00006 (FLIP BACK MULTI-AXIS)**  
**2F) 020-00007 (STANDARD 90°)**  
**2G) 020-00008 (MULTI-AXIS)**  
**2H) 020-00009 (DEPORTEE)**

## ③ SHOULDER SUPPORT

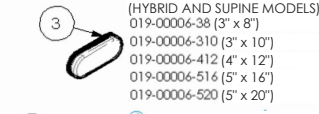

- (HYBRID AND SUPINE MODELS)  
019-00006-38 (3" x 8")  
019-00006-310 (3" x 10")  
019-00006-412 (4" x 12")  
019-00006-516 (5" x 16")  
019-00006-520 (5" x 20")

## ④ THORACIC SUPPORT

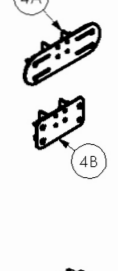

- 4A) STANDARD THORACIC**  
019-00007-B (BABY)  
019-00007-K (KID)  
019-00007-J (JUNIOR)
- 4A) STANDARD HIP**  
019-00020-B (BABY)  
019-00020-K (KID)  
019-00020-J (JUNIOR)
- 4B) SHORT THORACIC**  
019-00007-BS (BABY)  
019-00007-KS (KID)  
019-00007-JS (JUNIOR)

## ⑤ MAST SET

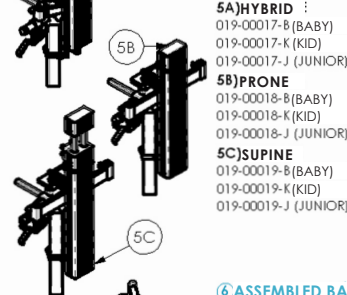

- 5A) HYBRID**  
019-00017-B (BABY)  
019-00017-K (KID)  
019-00017-J (JUNIOR)
- 5B) PRONE**  
019-00018-B (BABY)  
019-00018-K (KID)  
019-00018-J (JUNIOR)
- 5C) SUPINE**  
019-00019-B (BABY)  
019-00019-K (KID)  
019-00019-J (JUNIOR)

## ⑥ ASSEMBLED BASE

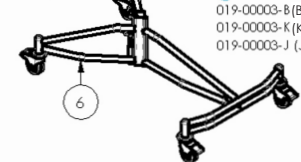

- 019-00003-B (BABY)  
019-00003-K (KID)  
019-00003-J (JUNIOR)

## ⑦ SOFT PADDED STRAP



- 7) THORACIC**  
019-00028-35 (3" x 5")  
019-00028-36 (3" x 6")  
019-00028-37 (3" x 7")  
019-00028-48 (4" x 8")  
019-00028-410 (4" x 10")  
019-00028-413 (4" x 13")
- 7) HIP**  
019-00029-35 (3" x 5")  
019-00029-36 (3" x 6")  
019-00029-37 (3" x 7")  
019-00029-48 (4" x 8")  
019-00029-410 (4" x 10")  
019-00029-413 (4" x 13")

## ⑧ PADDED STRAP



- 8) HIP**  
019-00035-35 (3" x 5")  
01900035-36 (3" x 6")  
019-00035-37 (3" x 7")  
019-00035-48 (4" x 8")  
019-00035-410 (4" x 10")  
019-00035-413 (4" x 13")

## ⑨ AXILLA SUPPORT



- 9A) STANDARD THORACIC**  
019-00034-BK03 (4" x 3")  
019-00034-BK04 (4" x 4")  
019-00034-BK05 (4" x 5")  
019-00034-BK06 (4" x 6")  
019-00034-BK07 (4" x 7")  
019-00034-BK08 (4" x 8")  
019-00034-BK09 (5" x 9")  
019-00034-BK10 (5" x 10")



- 9B) SWING AWAY**  
019-00041-BK04 (4" x 4")  
019-00041-BK05 (4" x 5")  
019-00041-BK06 (4" x 6")  
019-00041-BK07 (4" x 7")  
019-00041-J05 (5" x 5")  
019-00041-J06 (5" x 6")  
019-00041-J07 (5" x 7")  
019-00041-J08 (5" x 8")  
019-00041-J09 (5" x 9")  
019-00041-J10 (5" x 10")



- 9C) ELBOW STOP THORACIC**  
019-00042-BK03 (4" x 3")  
019-00042-BK04 (4" x 4")  
019-00042-BK05 (4" x 5")  
019-00042-BK06 (4" x 6")  
019-00042-BK07 (4" x 7")  
019-00042-J05 (5" x 5")  
019-00042-J06 (5" x 6")  
019-00042-J07 (5" x 7")  
019-00042-J08 (5" x 8")  
019-00042-J09 (5" x 9")  
019-00042-J10 (5" x 10")

## ⑩ HIP SUPPORT



- 10A) STANDARD HIP**  
019-00053-BK3 (4" x 3")  
019-00053-BK4 (4" x 4")  
019-00053-BK5 (4" x 5")  
019-00053-BK6 (4" x 6")  
019-00053-BK7 (4" x 7")  
019-00053-J05 (5" x 5")  
019-00053-J06 (5" x 6")  
019-00053-J07 (5" x 7")  
019-00053-J08 (5" x 8")  
019-00053-J09 (5" x 9")  
019-00053-J10 (5" x 10")

## ⑩B) SWING AWAY

- 019-00036-BK04 (4" x 4")  
019-00036-BK05 (4" x 5")  
019-00036-BK06 (4" x 6")  
019-00036-BK07 (4" x 7")  
019-00036-J05 (5" x 5")  
019-00036-J06 (5" x 6")  
019-00036-J07 (5" x 7")  
019-00036-J08 (5" x 8")  
019-00036-J09 (5" x 9")  
019-00036-J10 (5" x 10")

## ⑪ KNEE SUPPORT

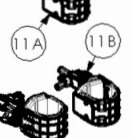

- 11A) STANDARD**  
019-00032-B (BABY)  
019-00032-K (KID)  
019-00032-J (JUNIOR)
- 11B) MULTI-AXIS**  
019-00030-B (BABY)  
019-00030-K (KID)  
019-00030-J (JUNIOR)

## ⑫ 60° LEG SYSTEM

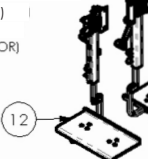

- 019-00009-B (BABY)  
019-00009-K (KID)  
019-00009-J (JUNIOR)

## ⑬ HALF TRAY FOR TABLE

- 019-00046-20 (20")  
019-00046-22 (22")  
019-00046-24 (24")

## ⑭ TABLE

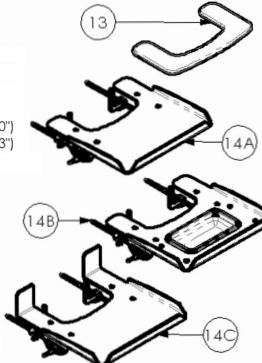

## 14A) STANDARD (LEXAN)

- 019-00011-20 (20")  
019-00011-22 (22")  
019-00011-24D (24")

## 14B) ACTIVITY BOWL (LEXAN)

- 019-00049-20 (20")  
019-00049-22 (22")  
019-00049-24D (24")

## 14C) ELBOW STOP (LEXAN)

- 019-00047-20 (20")  
019-00047-22 (22")  
019-00047-24D (24")

## 14A) STANDARD (ABS)

- 019-00010-20 (20")  
019-00010-22 (22")  
019-00010-24D (24")

## 14B) ACTIVITY BOWL (ABS)

- 019-00057-20 (20")  
019-00057-22 (22")  
019-00057-24D (24")

## 14C) ELBOW STOP (ABS)

- 019-00058-20 (20")  
019-00058-22 (22")  
019-00058-24D (24")

## ⑮ PUSH HANDLE

- (SUPINE AND HYBRID MODELS)  
019-00002

## ⑯ PRONE PADDED CHINREST

- 019-00052

## ⑰ UPPER BODY PLANAR PAD

- 019-00038-56 (5" x 6")  
019-00038-510 (5" x 10")  
019-00038-68 (6" x 8")  
019-00038-612 (6" x 12")  
019-00038-710 (7" x 10")  
019-00038-714 (7" x 14")  
019-00038-812 (8" x 12")  
019-00038-816 (8" x 16")  
019-00038-1016 (10" x 16")  
019-00038-1020 (10" x 20")  
019-00038-1318 (13" x 18")  
019-00038-1322 (13" x 22")

## ⑱ PRONE HEAD SUPPORT

- 019-00050-B (BABY)  
019-00050-K (KID)  
019-00050-J (JUNIOR)

## ⑲ THORACIC HARNESS

- 019-00044-S (SMALL)  
019-00044-M (MEDIUM)  
019-00044-L (LARGE)

## ⑳ FOOT SUPPORT

- 140-00001-1 (2 1/2" x 5 1/2")  
140-00001-2 (3" x 6 3/4")  
140-00001-3 (3" x 6 3/4")  
140-00001-4 (3 3/4" x 8 1/2")  
140-00001-5 (4" x 9")  
140-00001-6 (4 1/2" x 10 1/2")  
140-00001-7 (4 3/4" x 12")  
140-00001-8 (5" x 13")

## ㉓ TOE STRAP FOR FOOT HOLDER

- (FOOT SUPPORT EXCLUDED)  
140-00001-1TS (FOOT SUPPORT # 140-00001-1)  
140-00001-2TS (FOOT SUPPORT # 140-00001-2)  
140-00001-3TS (FOOT SUPPORT # 140-00001-3)  
140-00001-4TS (FOOT SUPPORT # 140-00001-4)  
140-00001-5TS (FOOT SUPPORT # 140-00001-5)  
140-00001-6TS (FOOT SUPPORT # 140-00001-6)  
140-00001-7TS (FOOT SUPPORT # 140-00001-7)  
140-00001-8TS (FOOT SUPPORT # 140-00001-8)

## ㉔ ABDUCTION SUPPORT

- 019-00008-B (BABY)  
019-00008-K (KID)  
019-00008-J (JUNIOR)

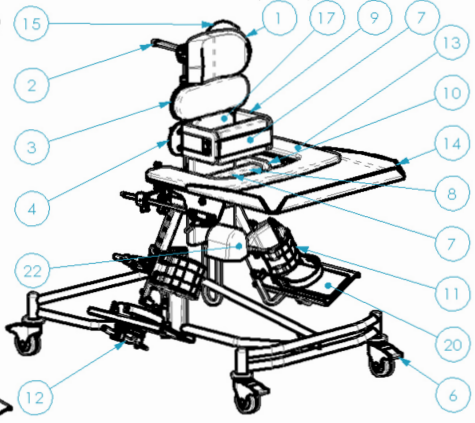

# CONTACT US



1242 de Lanaudière  
Joliette, Quebec  
Canada J6E 3P1



1 450 752-8818  
Fax: 450 752-1644



[www.synetikergocare.com](http://www.synetikergocare.com)